

Theme-Based Worksheets

NAME:

DATE:

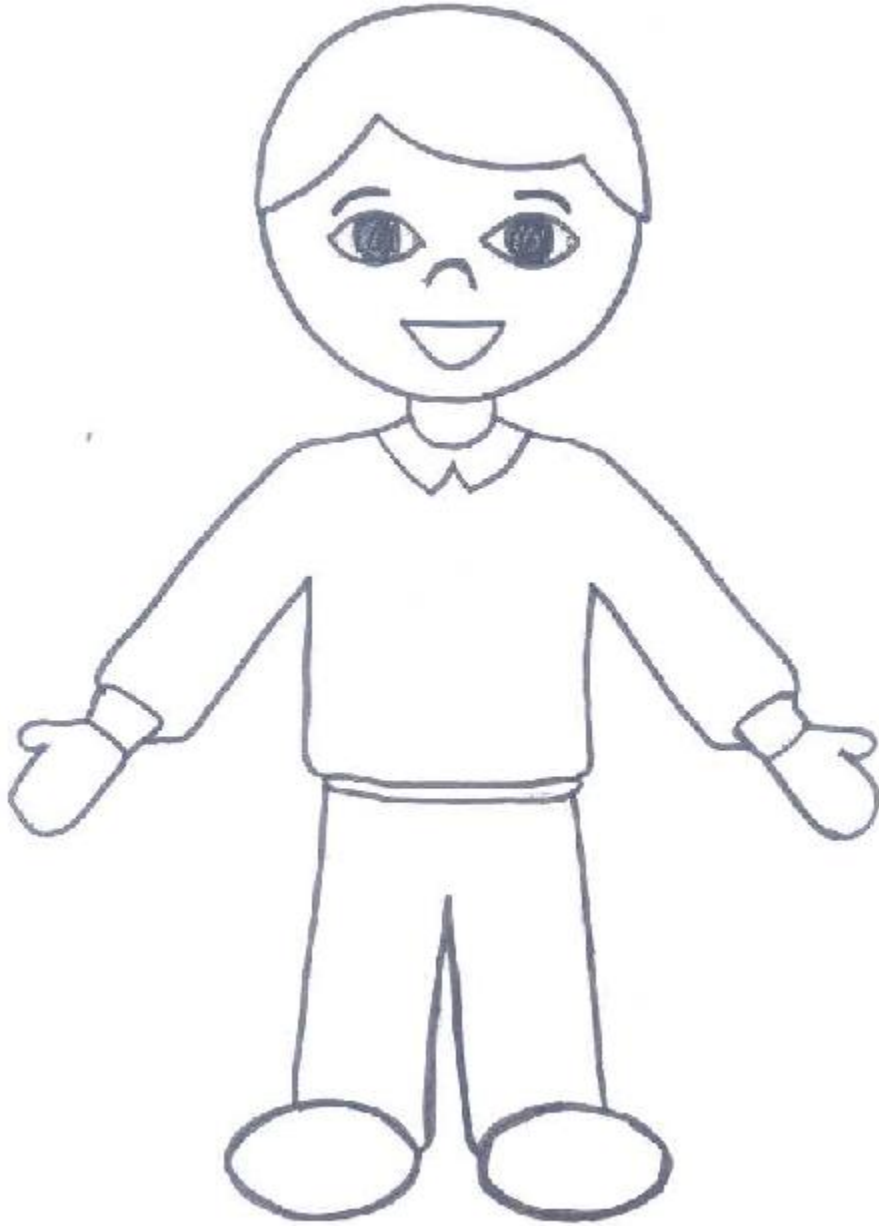

NAME:

DATE:



NAME:

DATE:



NAME:

DATE:

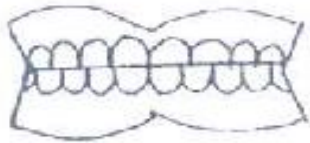

NAME:

DATE:

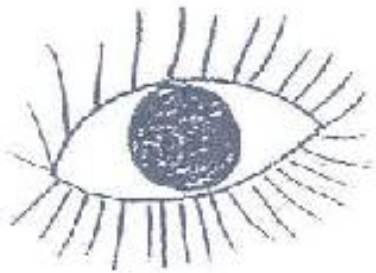

NAME:

DATE:

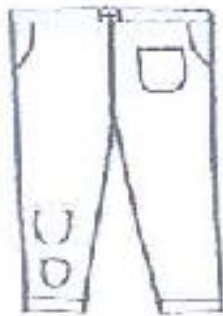

NAME:

DATE:



NAME:

DATE:

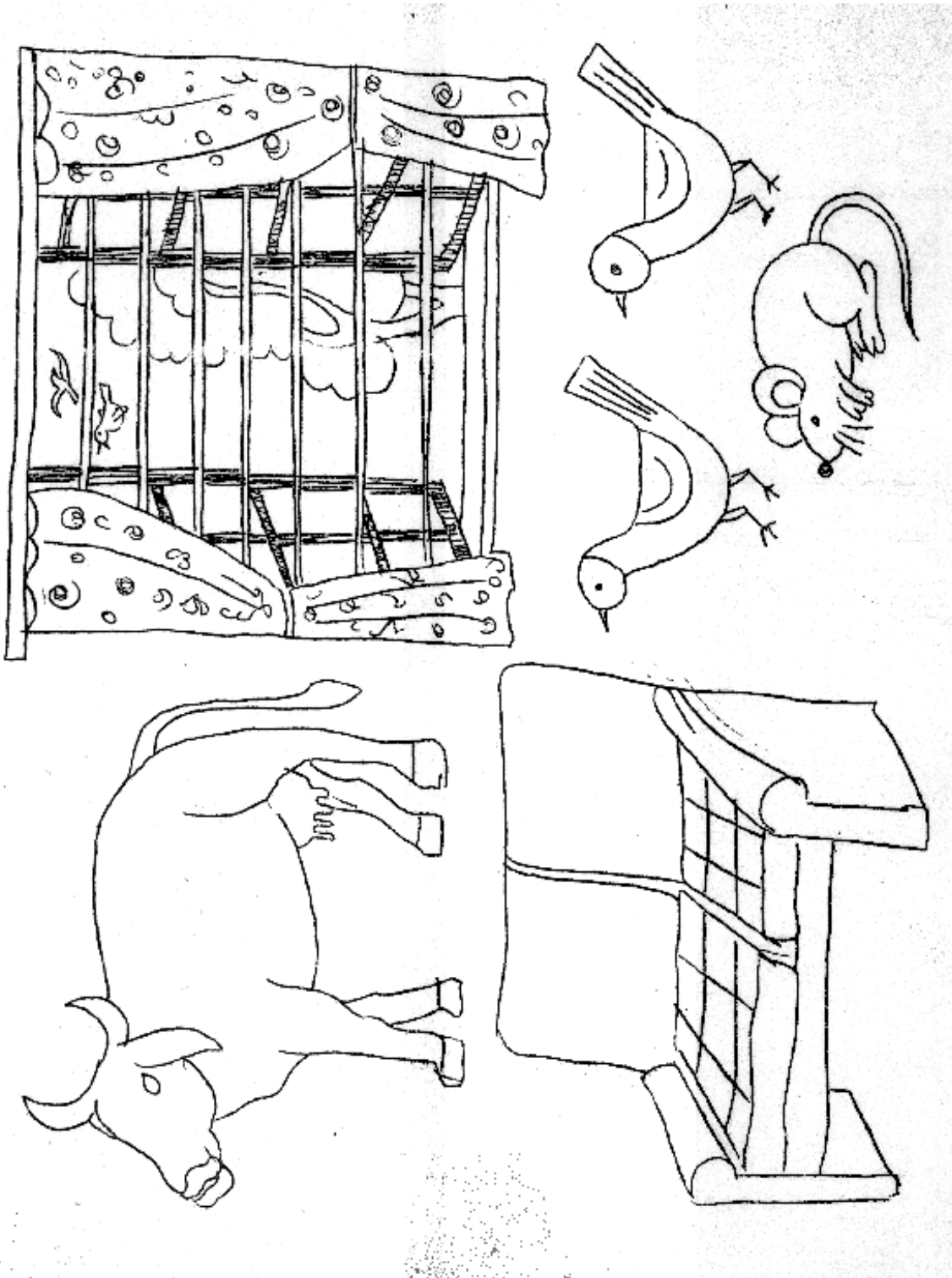

NAME:

DATE:

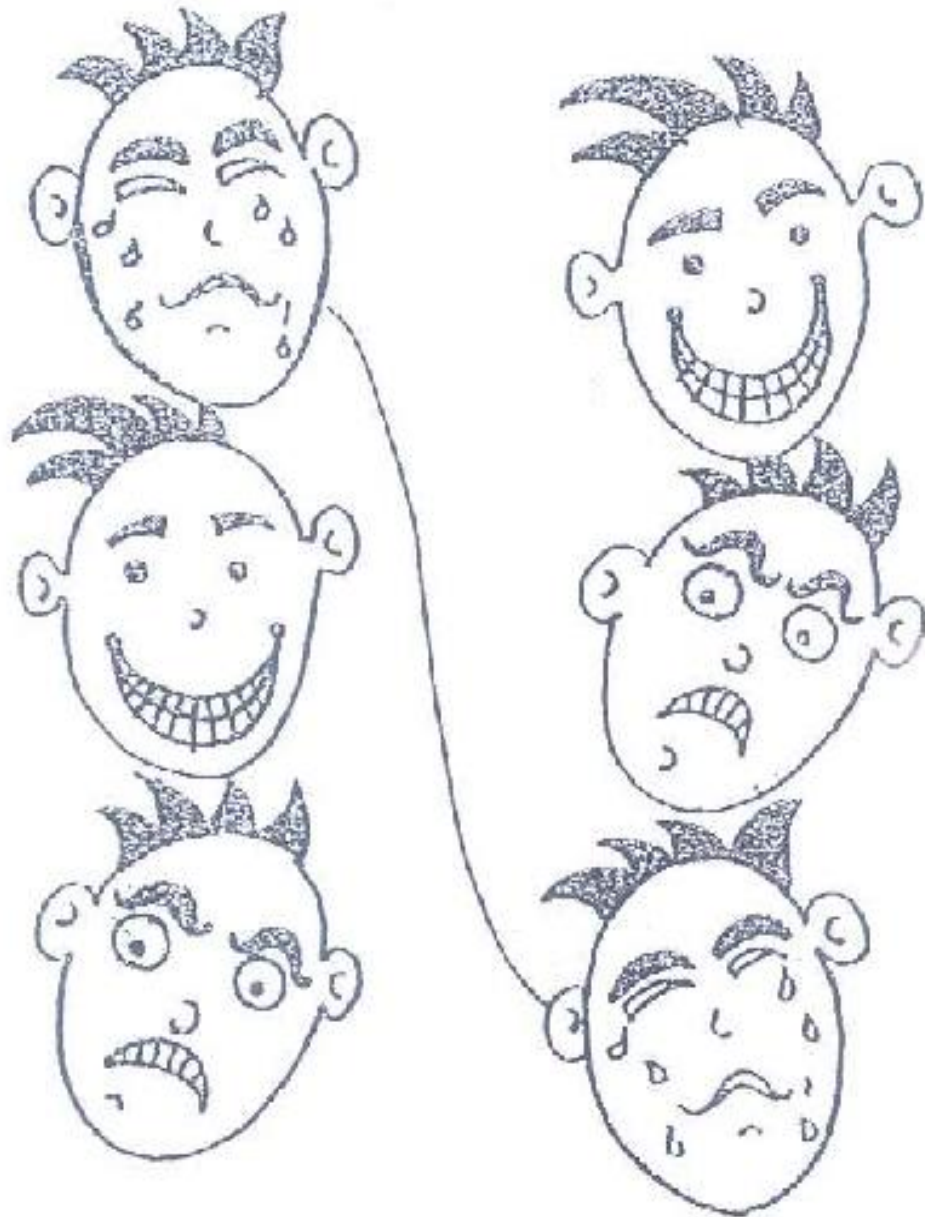

NAME:

DATE:

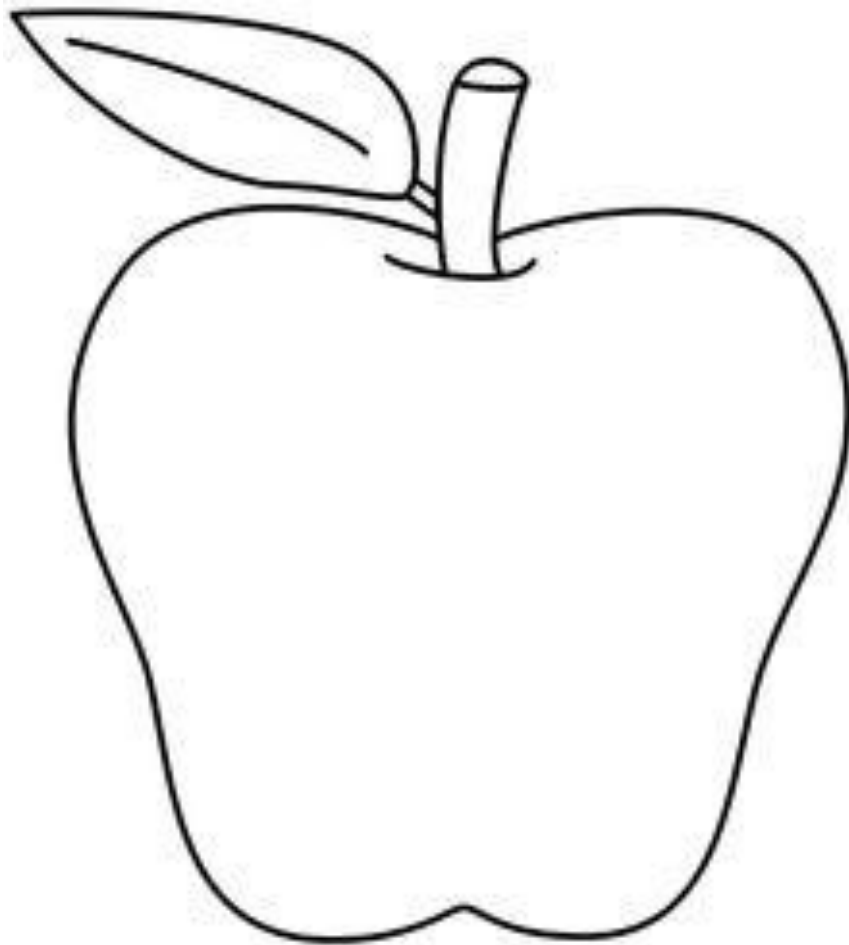

NAME:

DATE:

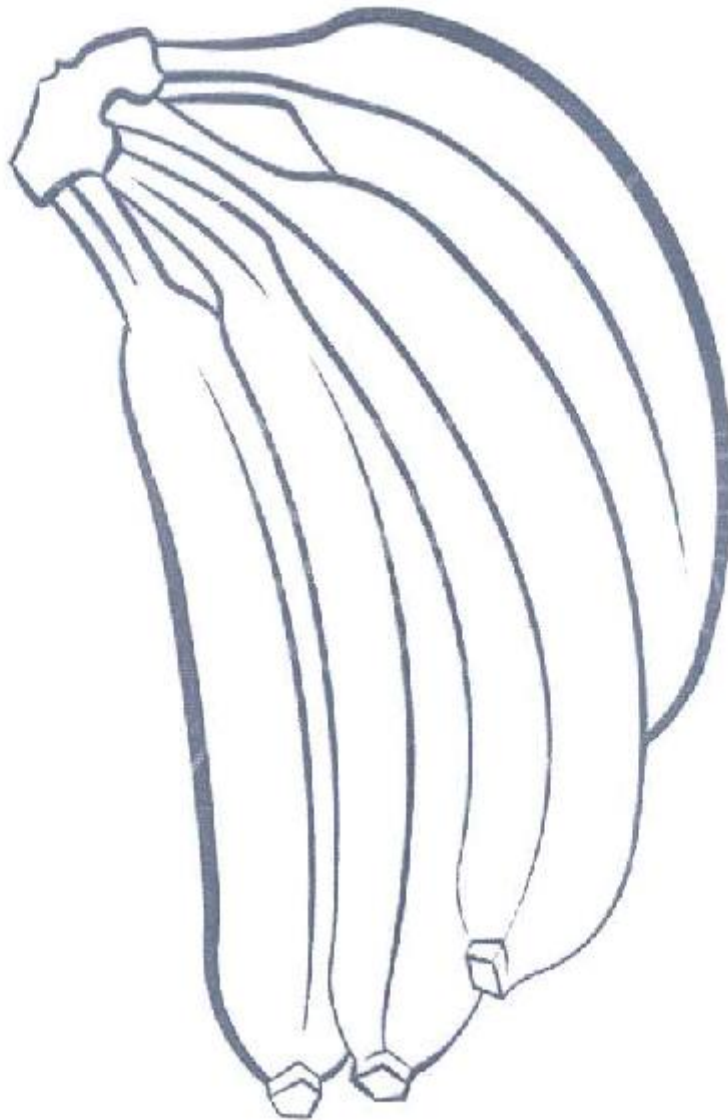

NAME:

DATE:

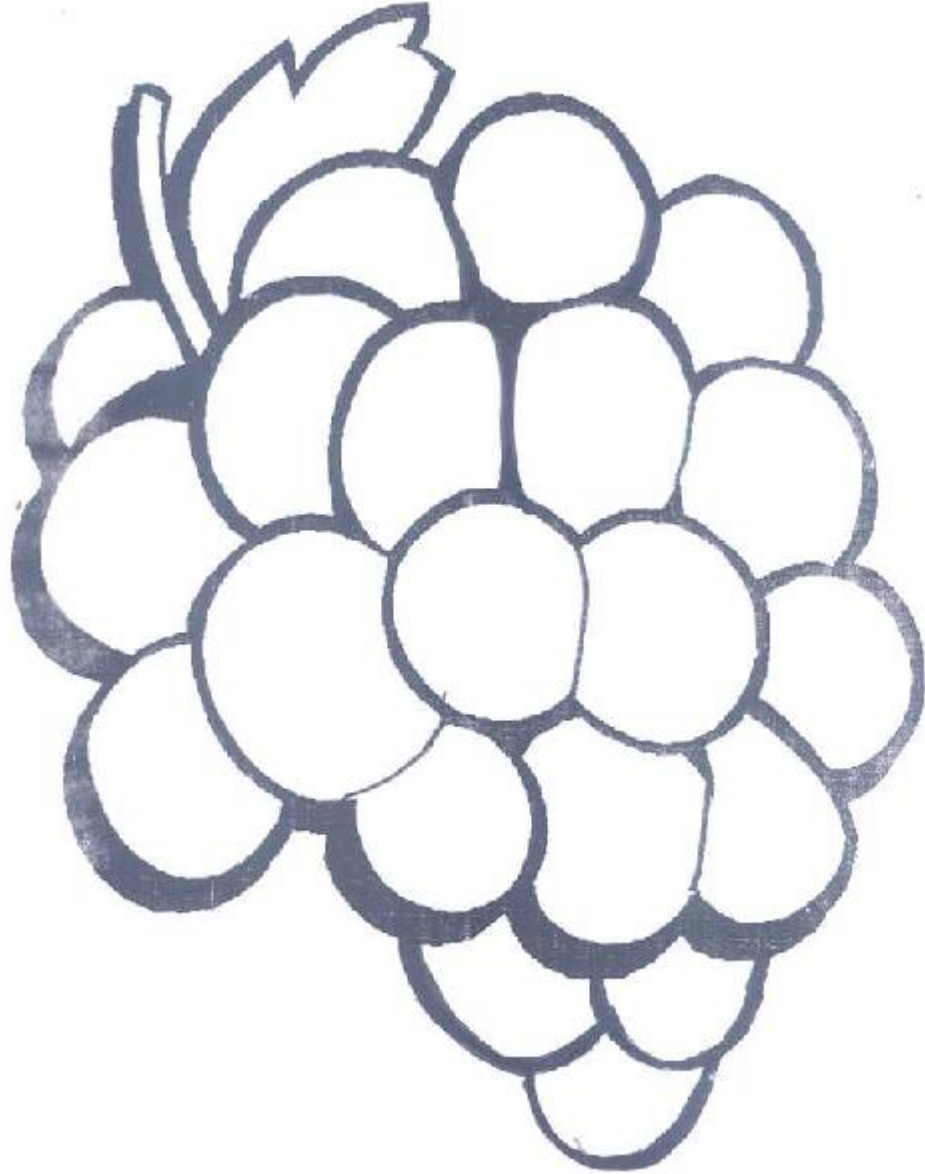

NAME:

DATE:

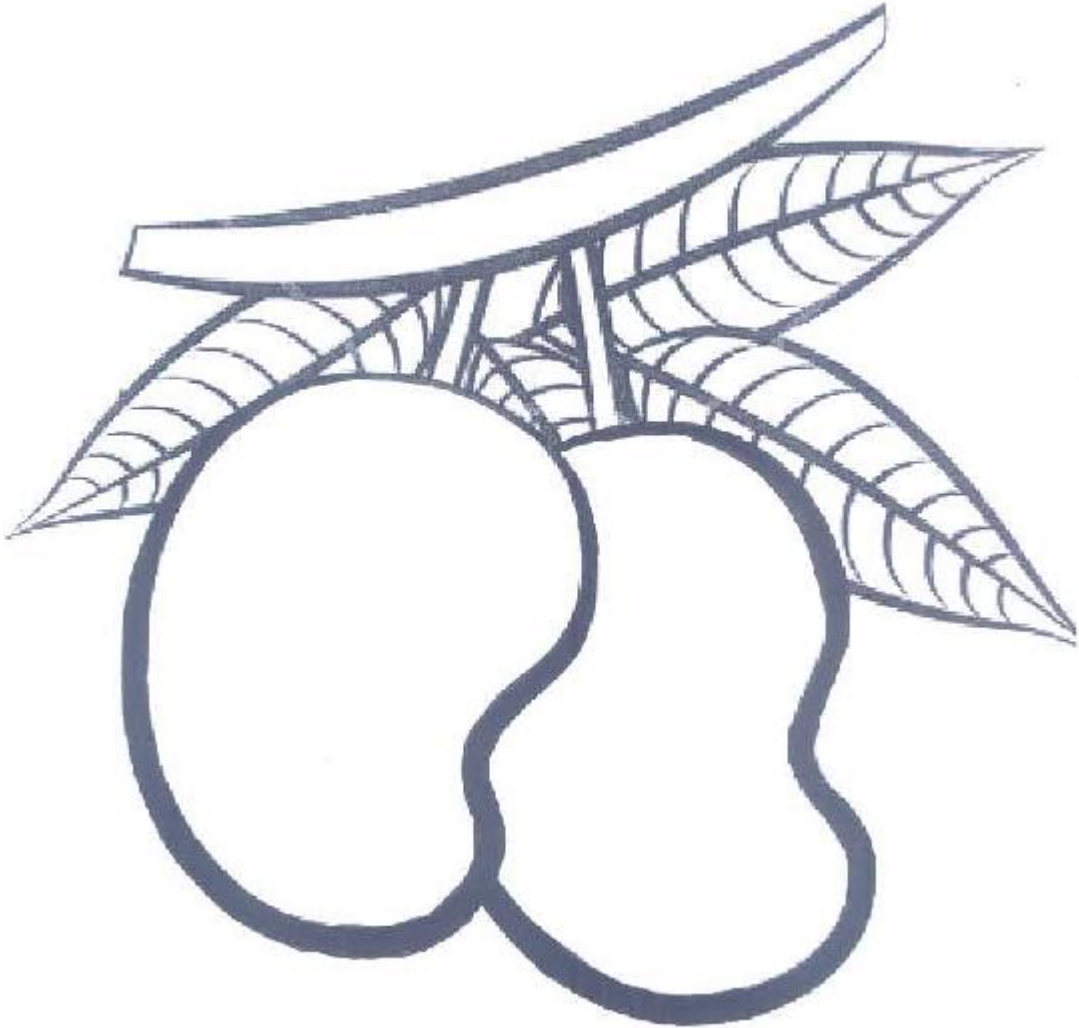

NAME:

DATE:

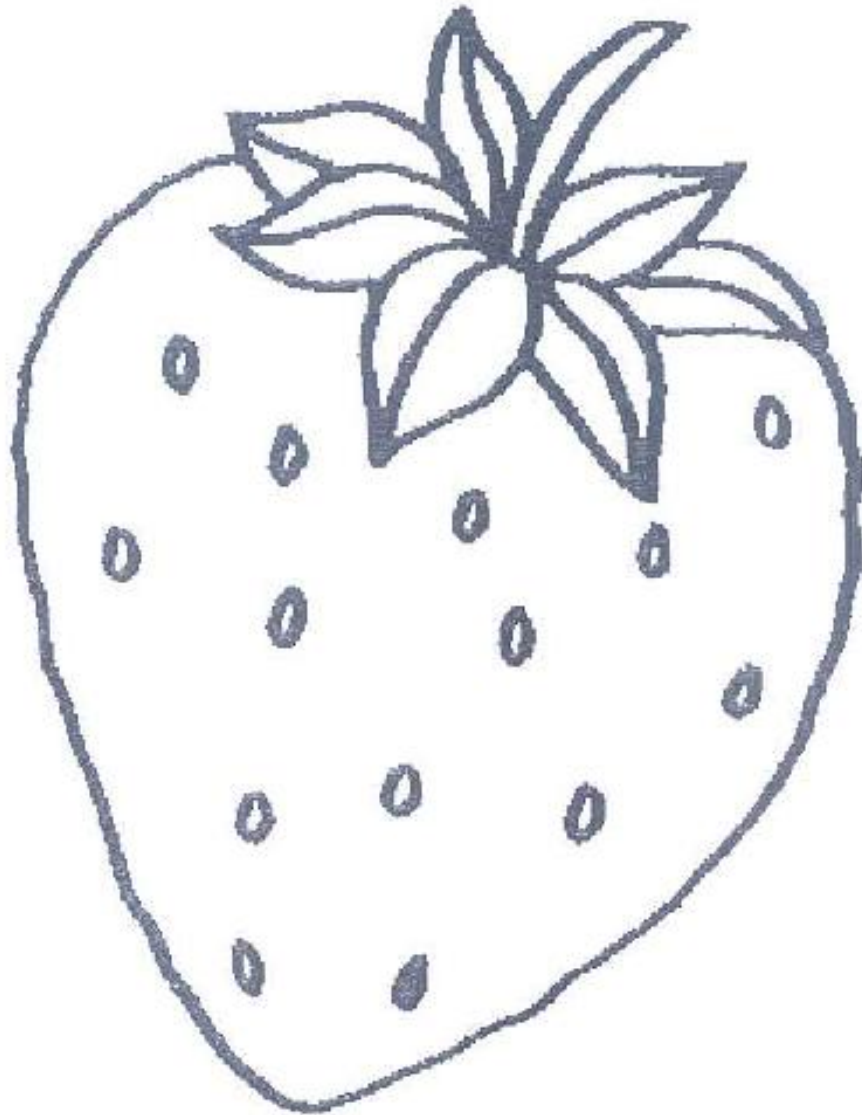

NAME:

DATE:

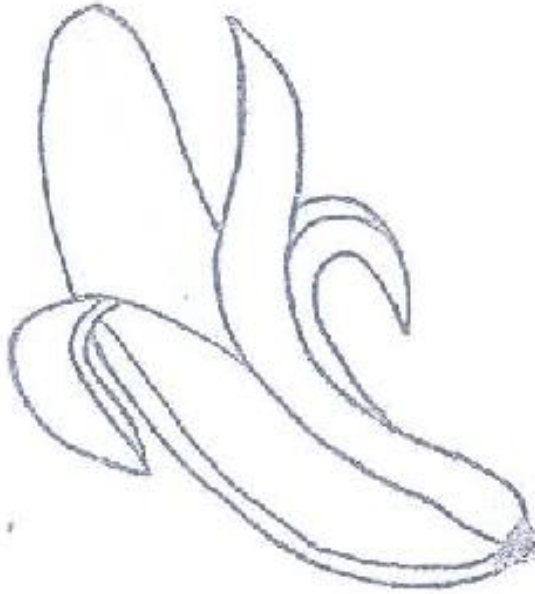

NAME:

DATE:

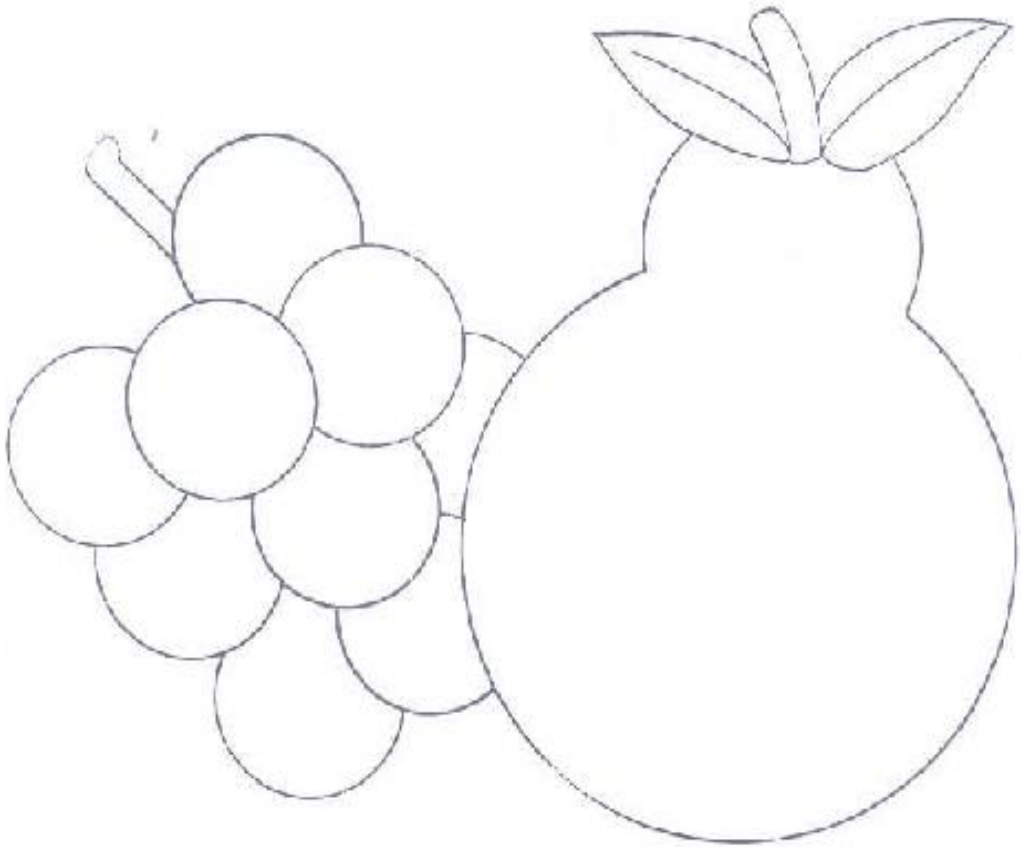

NAME:

DATE:

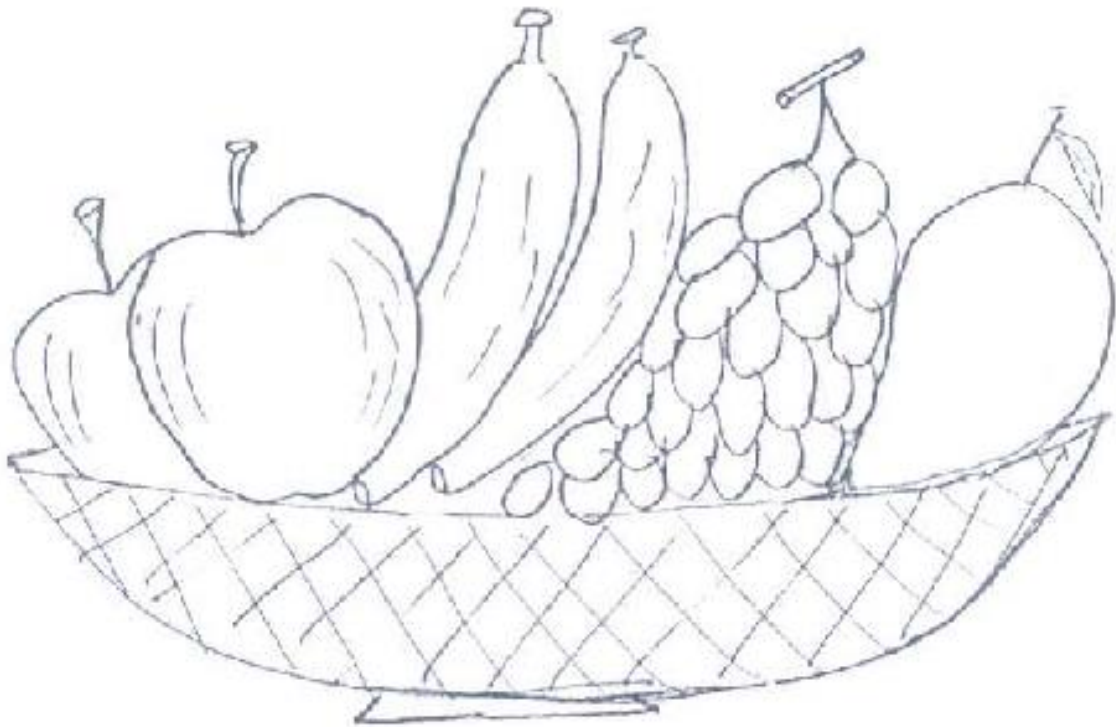

NAME:

DATE:

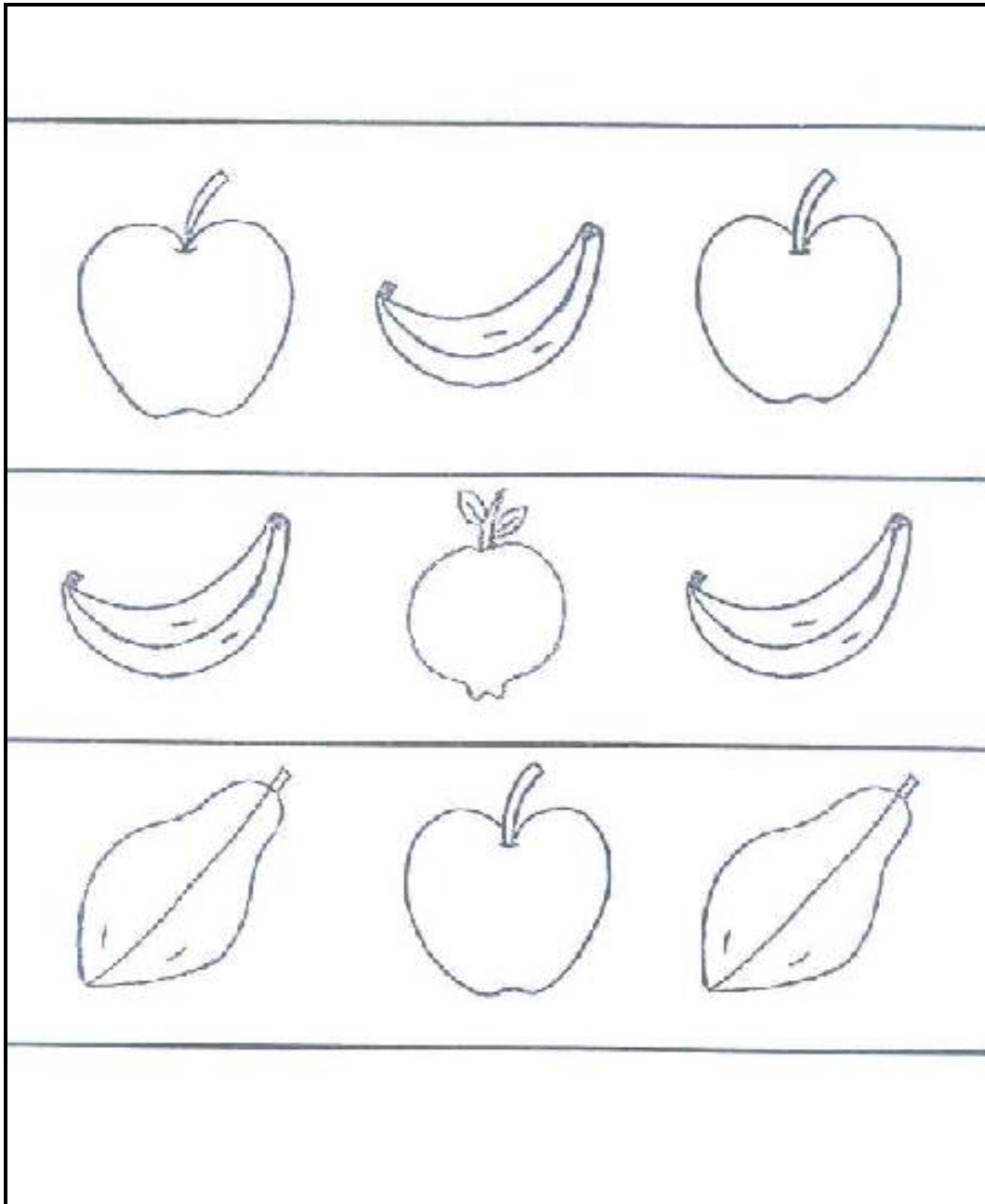

NAME:

DATE:

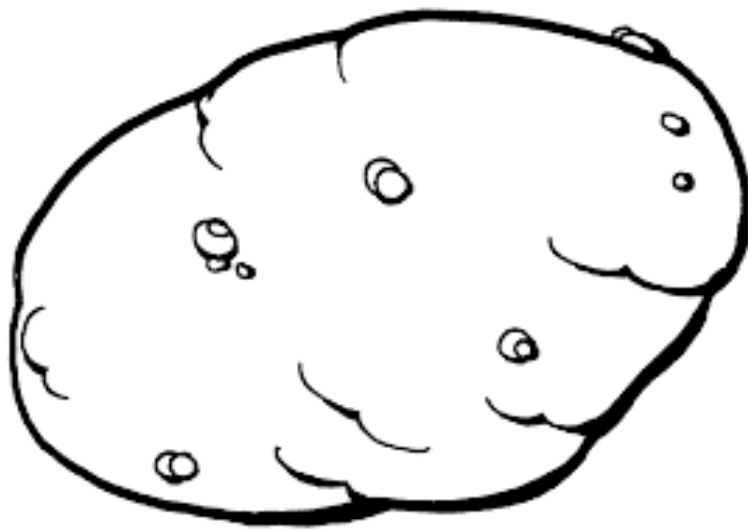

NAME:

DATE:



NAME:

DATE:



NAME:

DATE:



NAME:

DATE:

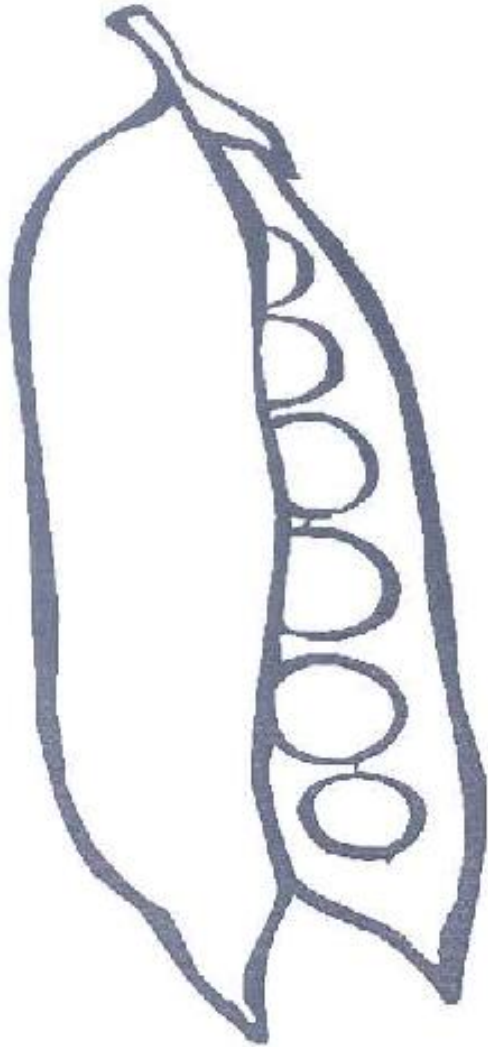

NAME:

DATE:

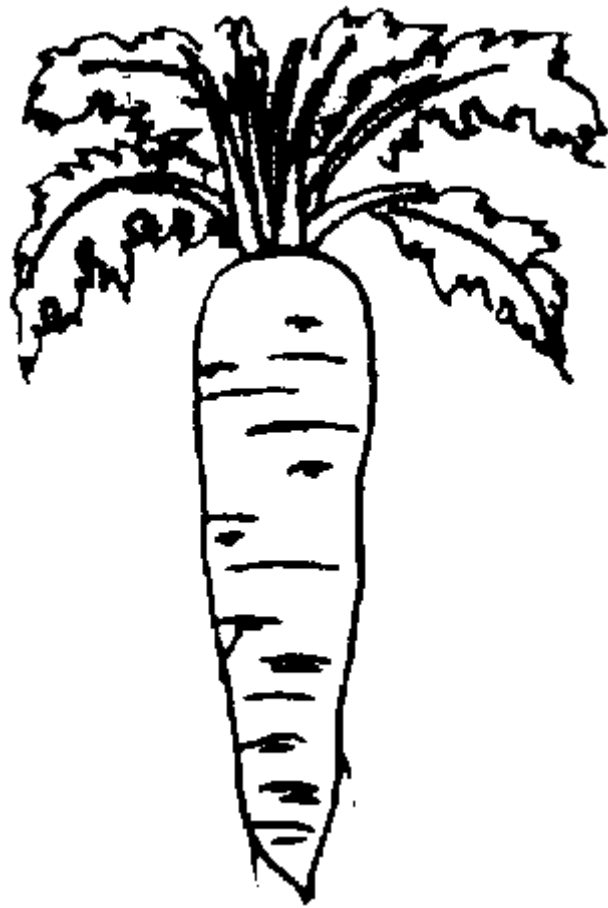

NAME:

DATE:

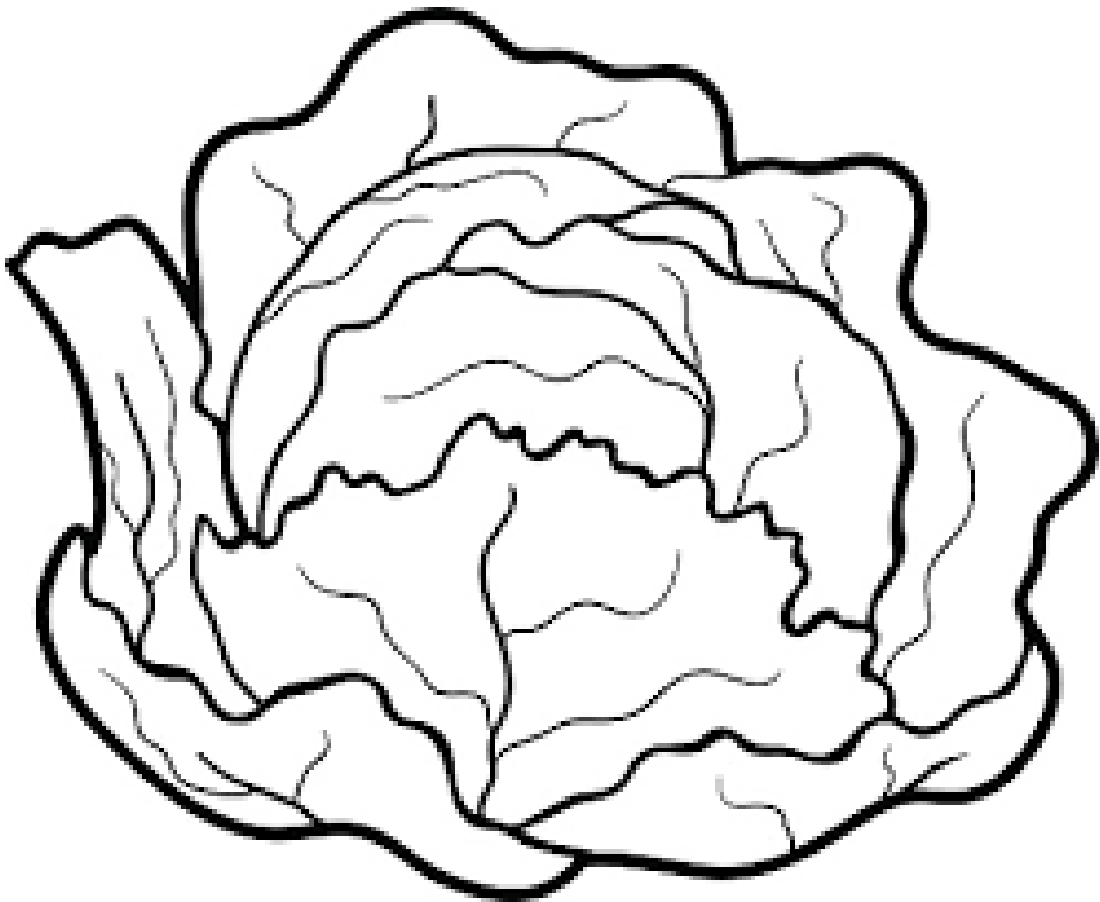

NAME:

DATE:

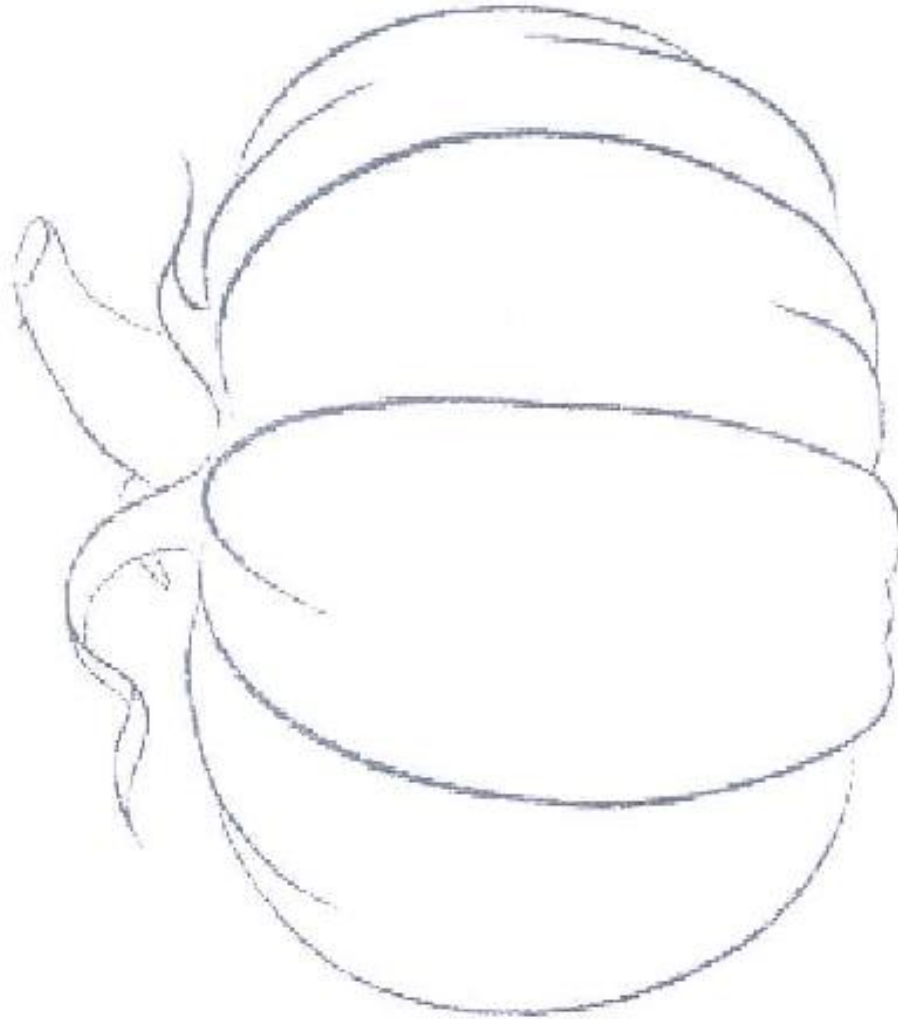

NAME:

DATE:

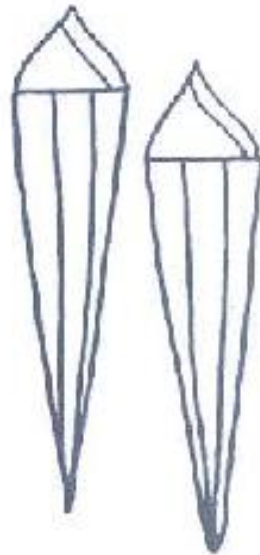
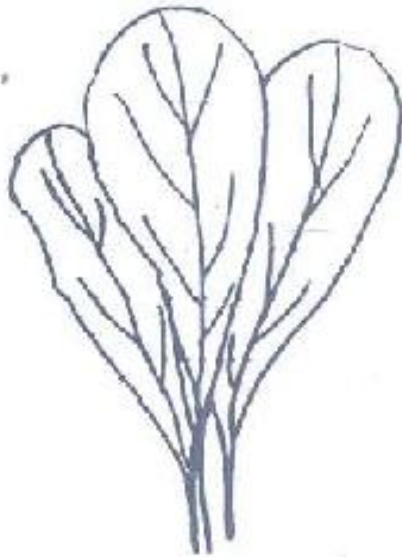
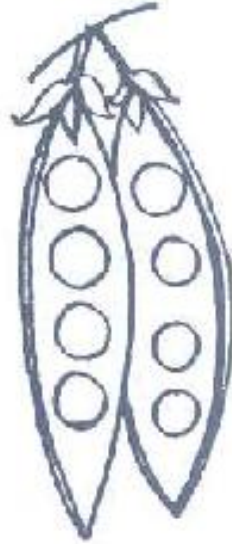

NAME:

DATE:

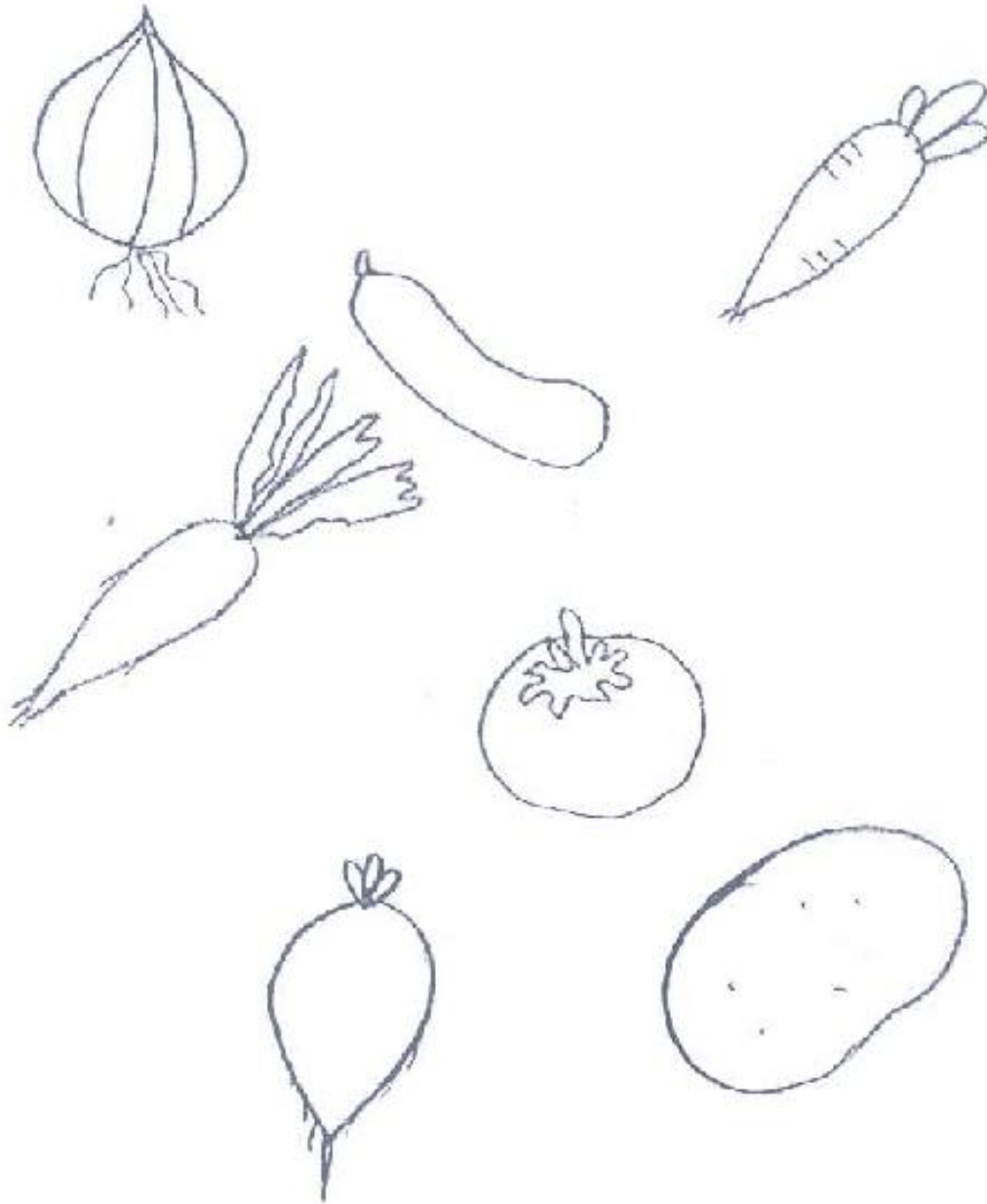

NAME:

DATE:

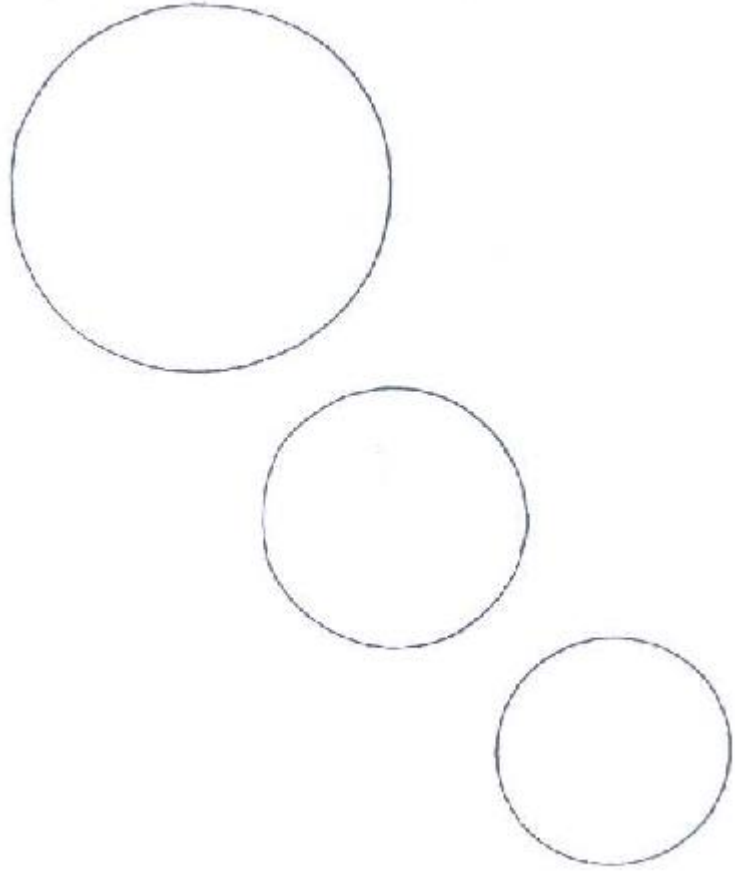

NAME:

DATE:

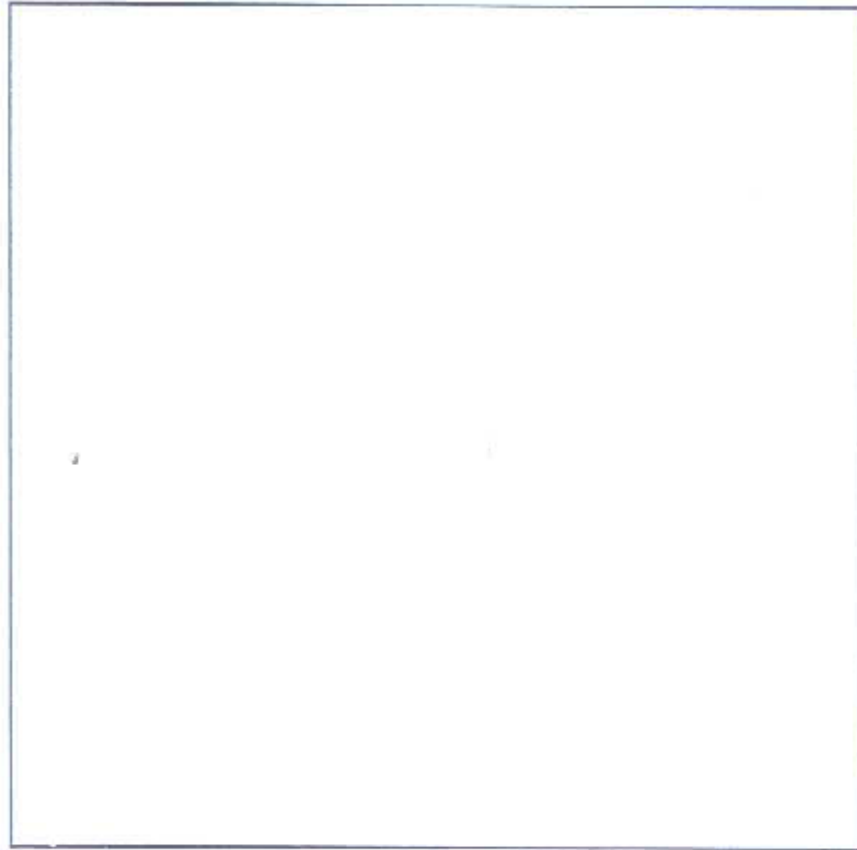

NAME:

DATE:

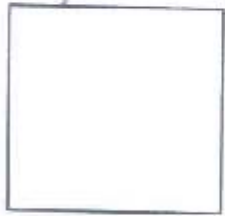
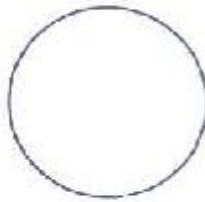
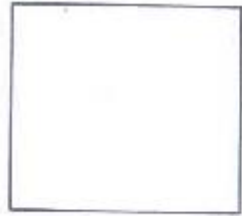

NAME:

DATE:

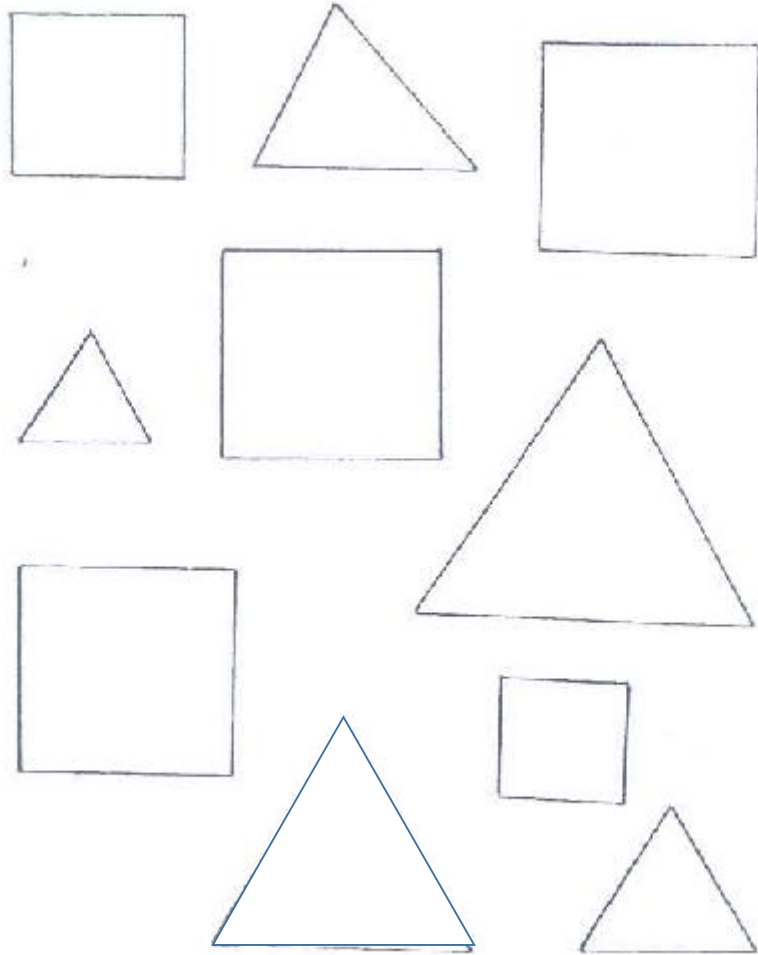

NAME:

DATE:

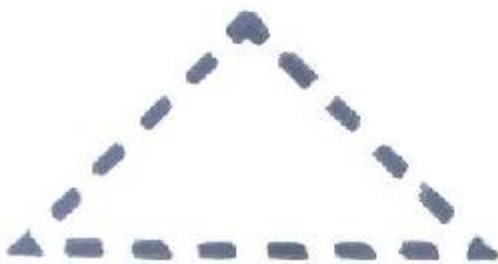
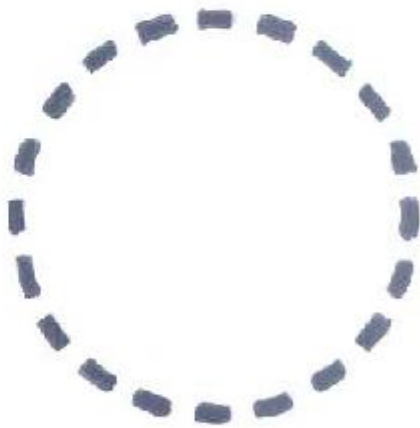
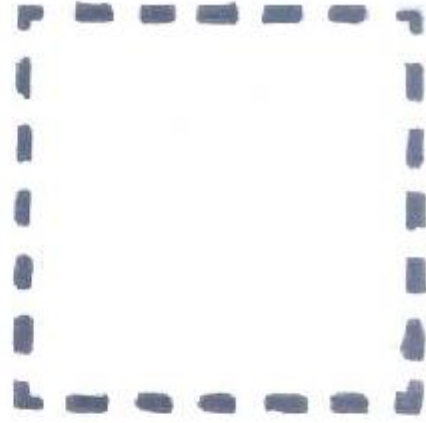

NAME:

DATE:

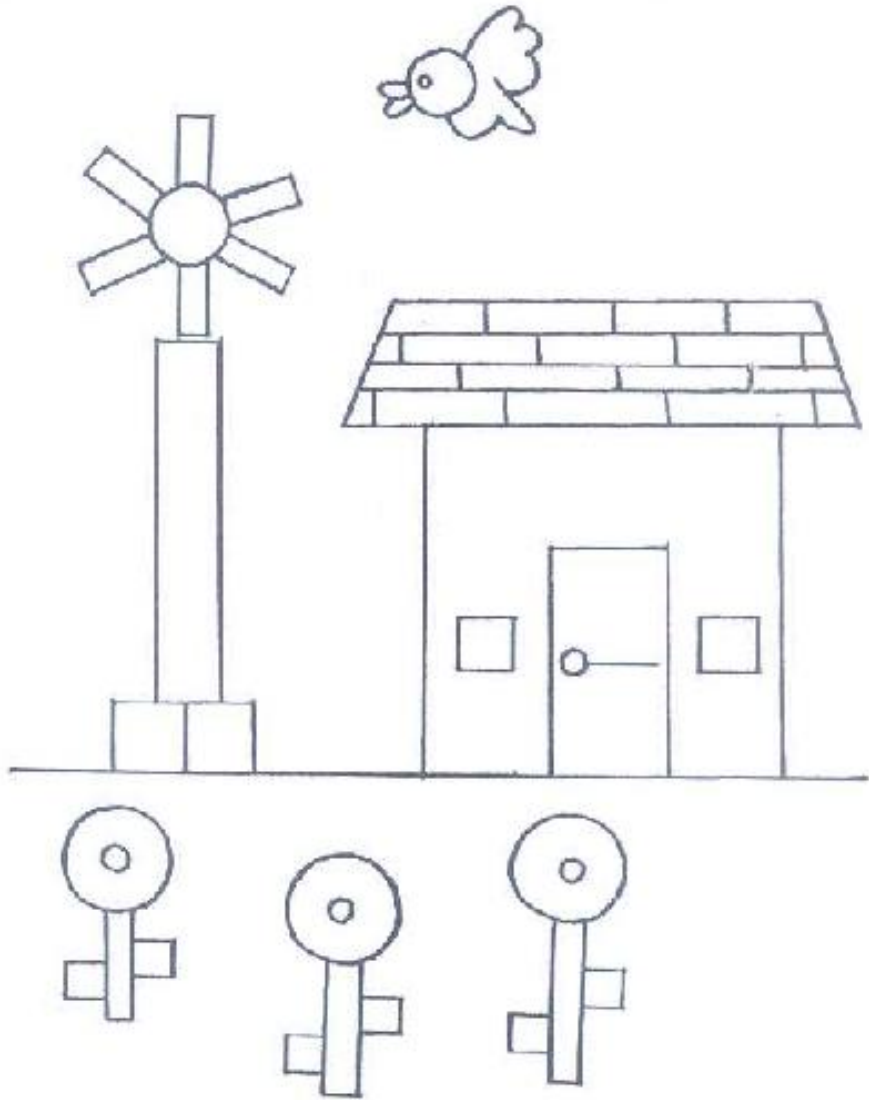

NAME:

DATE:

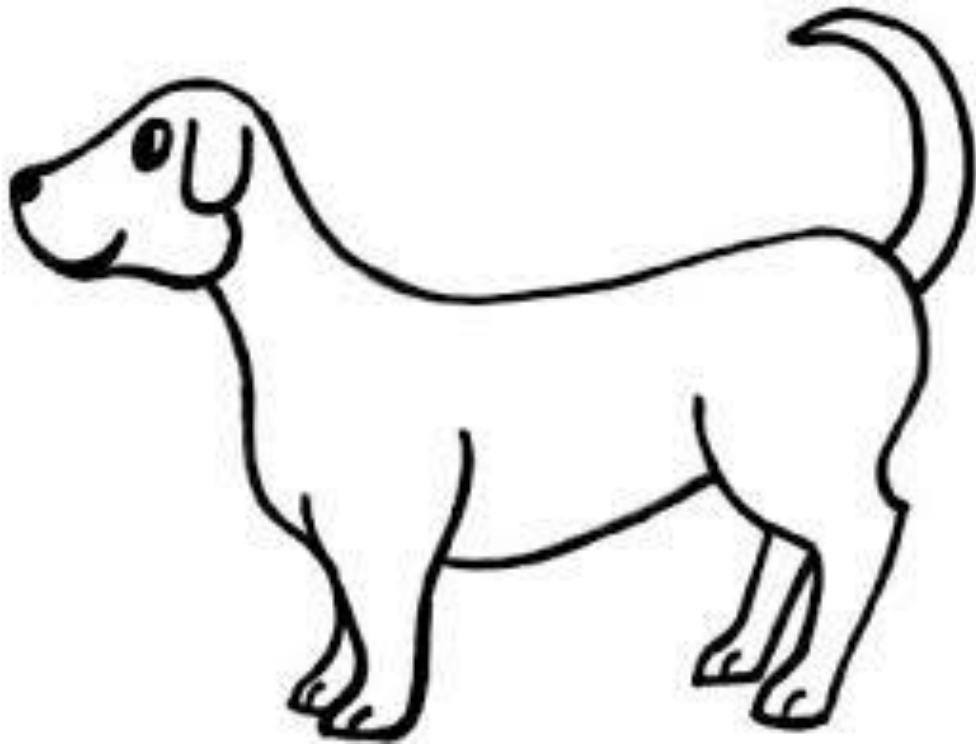

NAME:

DATE:

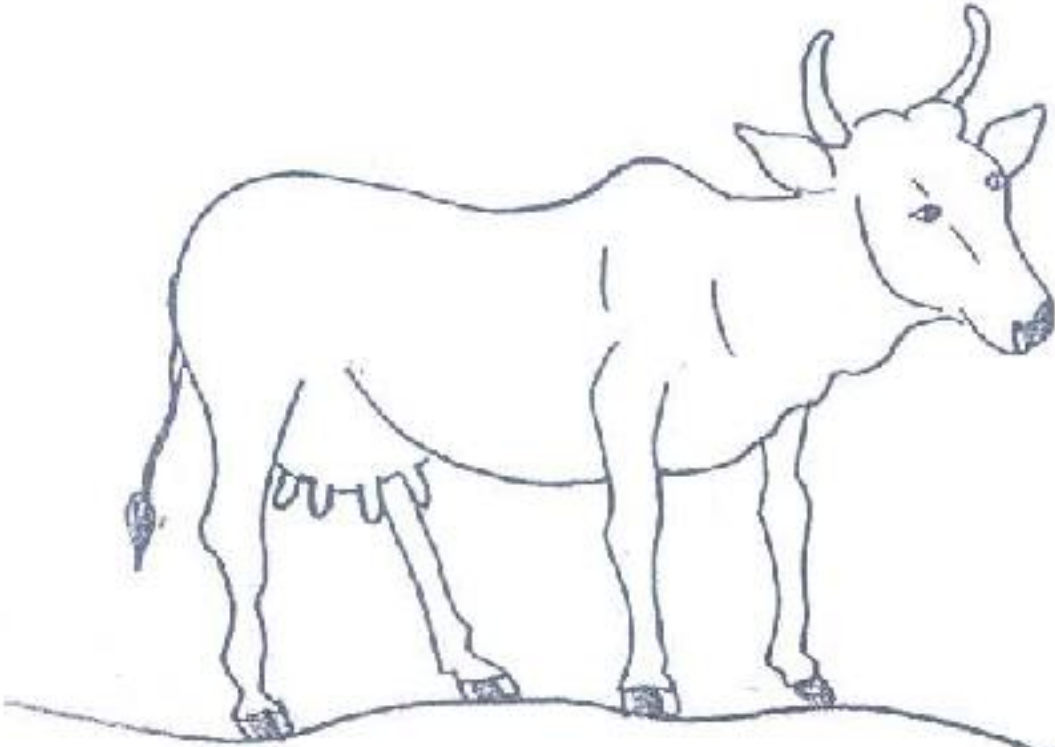

NAME:

DATE:

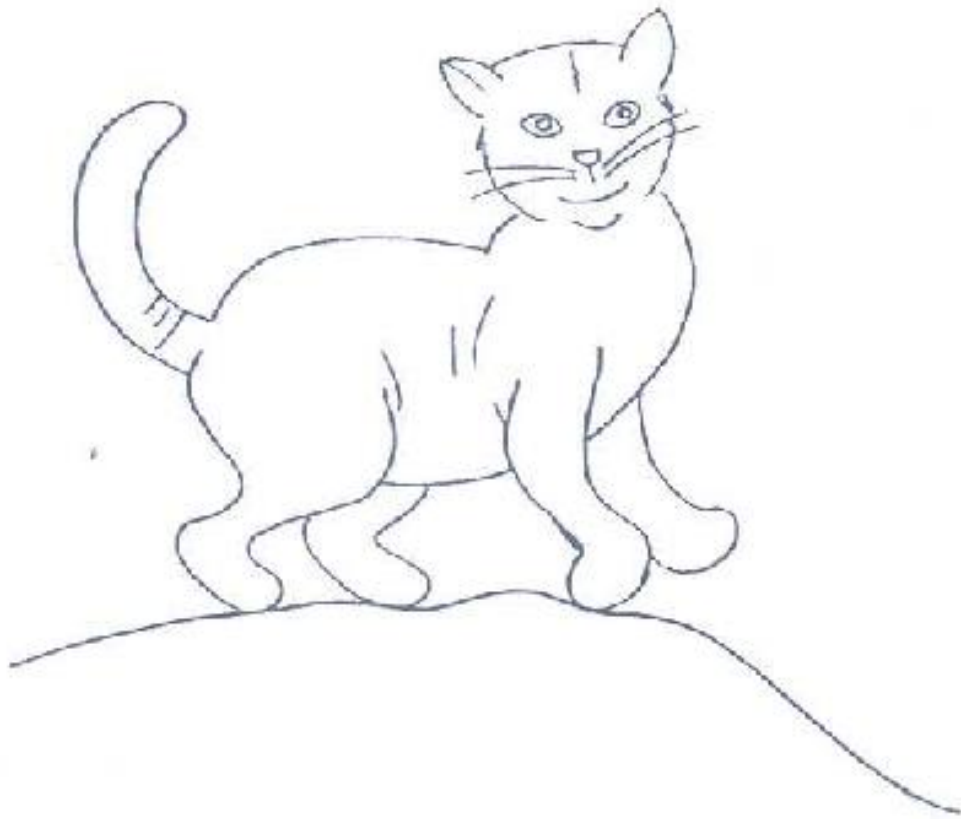

NAME:

DATE:



NAME:

DATE:

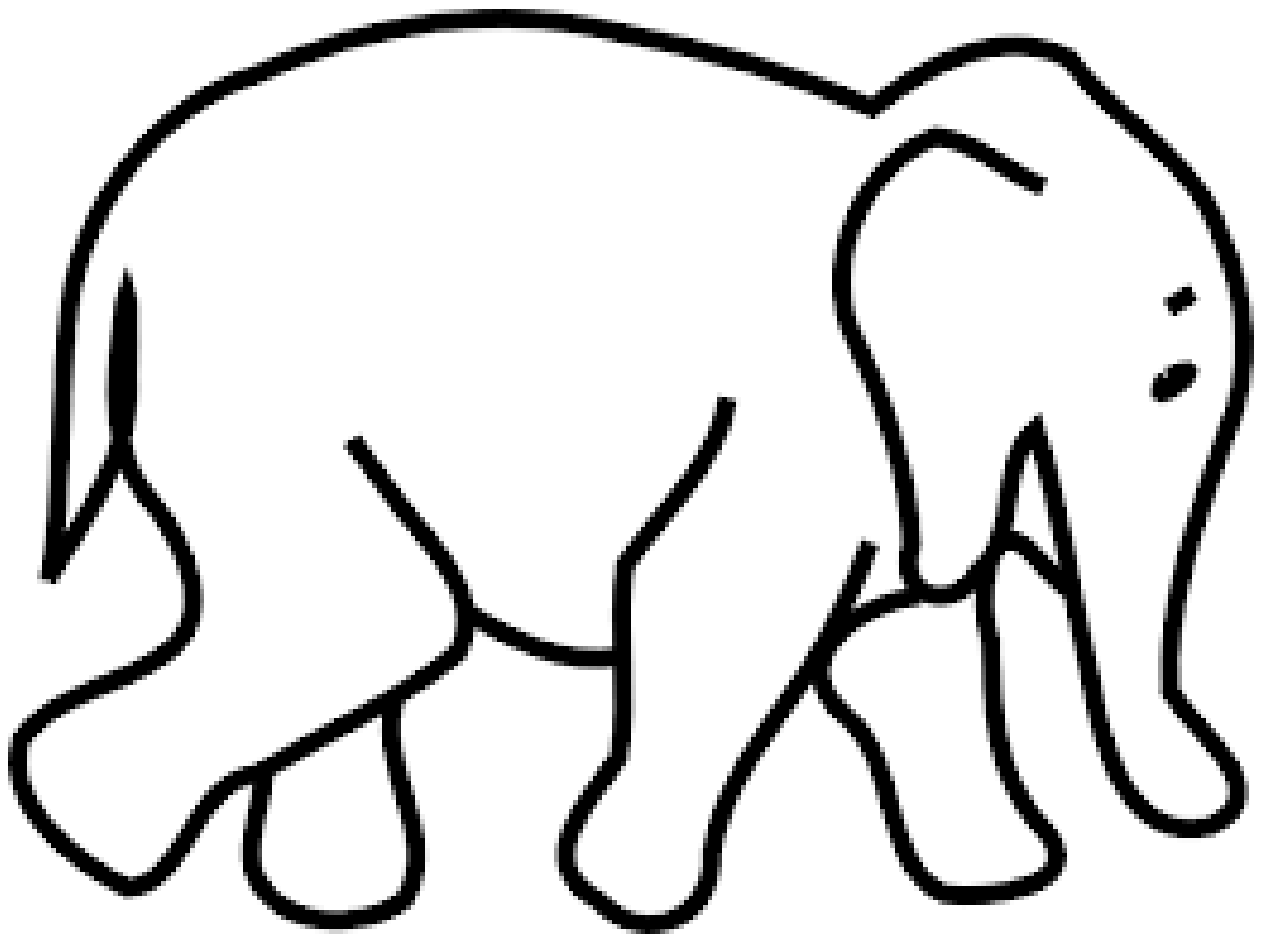

NAME:

DATE:



NAME:

DATE:

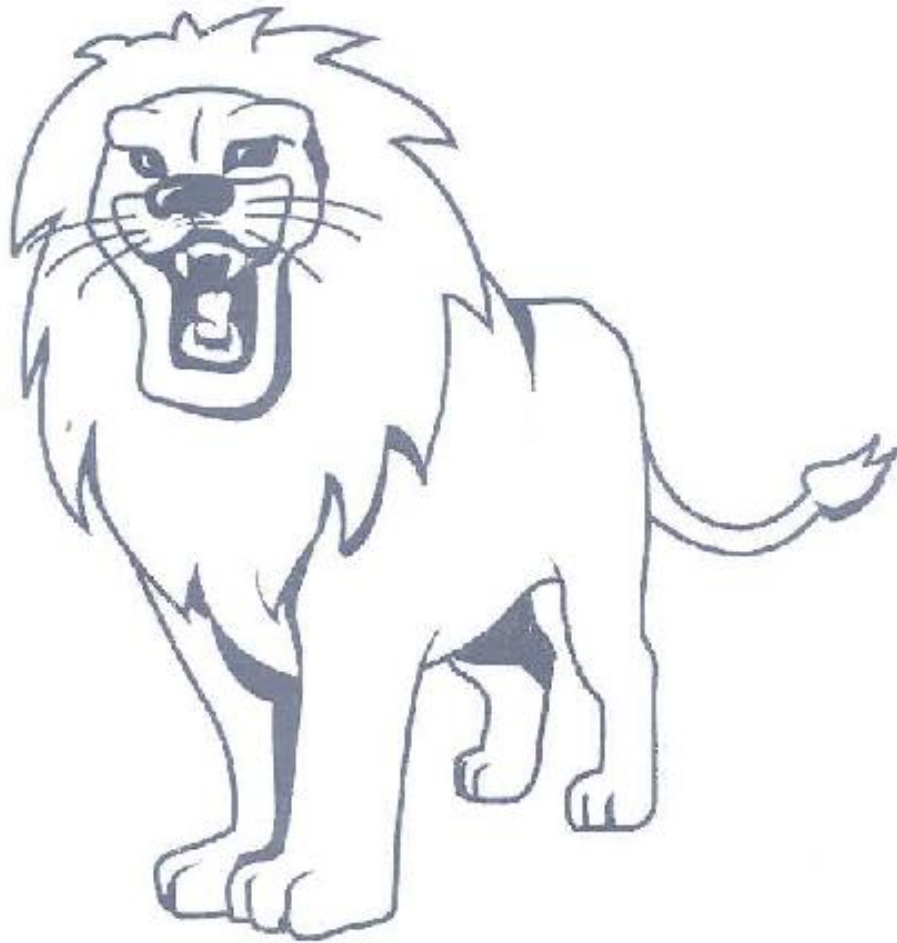

NAME:

DATE:

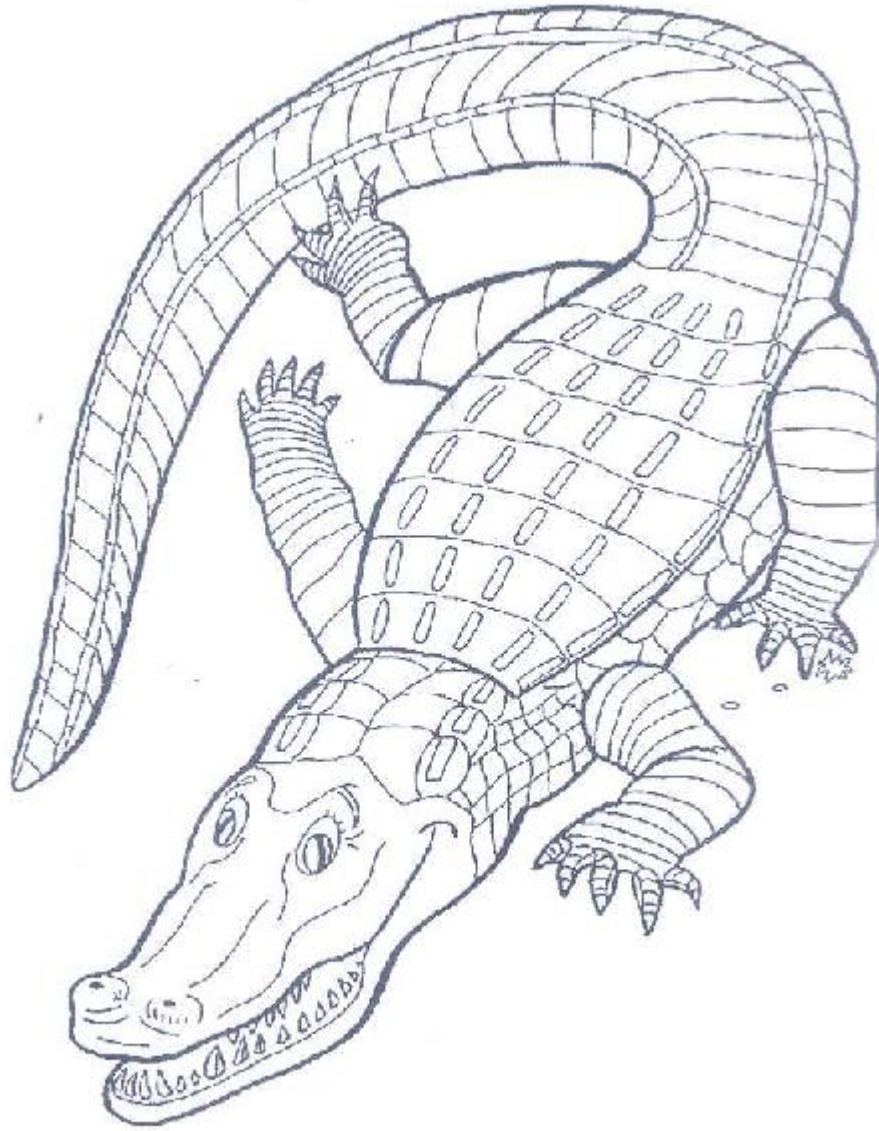

NAME:

DATE:

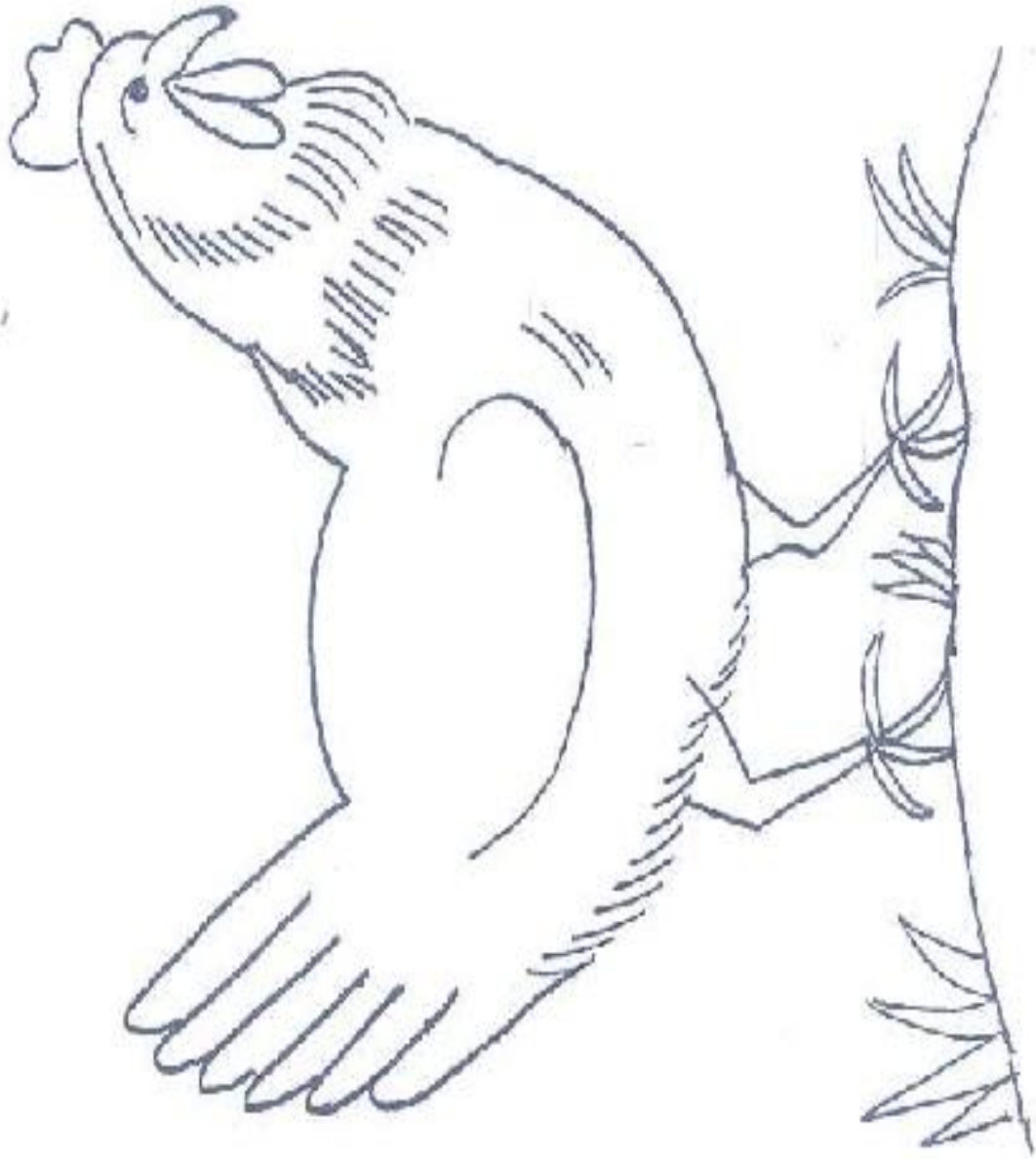

NAME:

DATE:



NAME:

DATE:

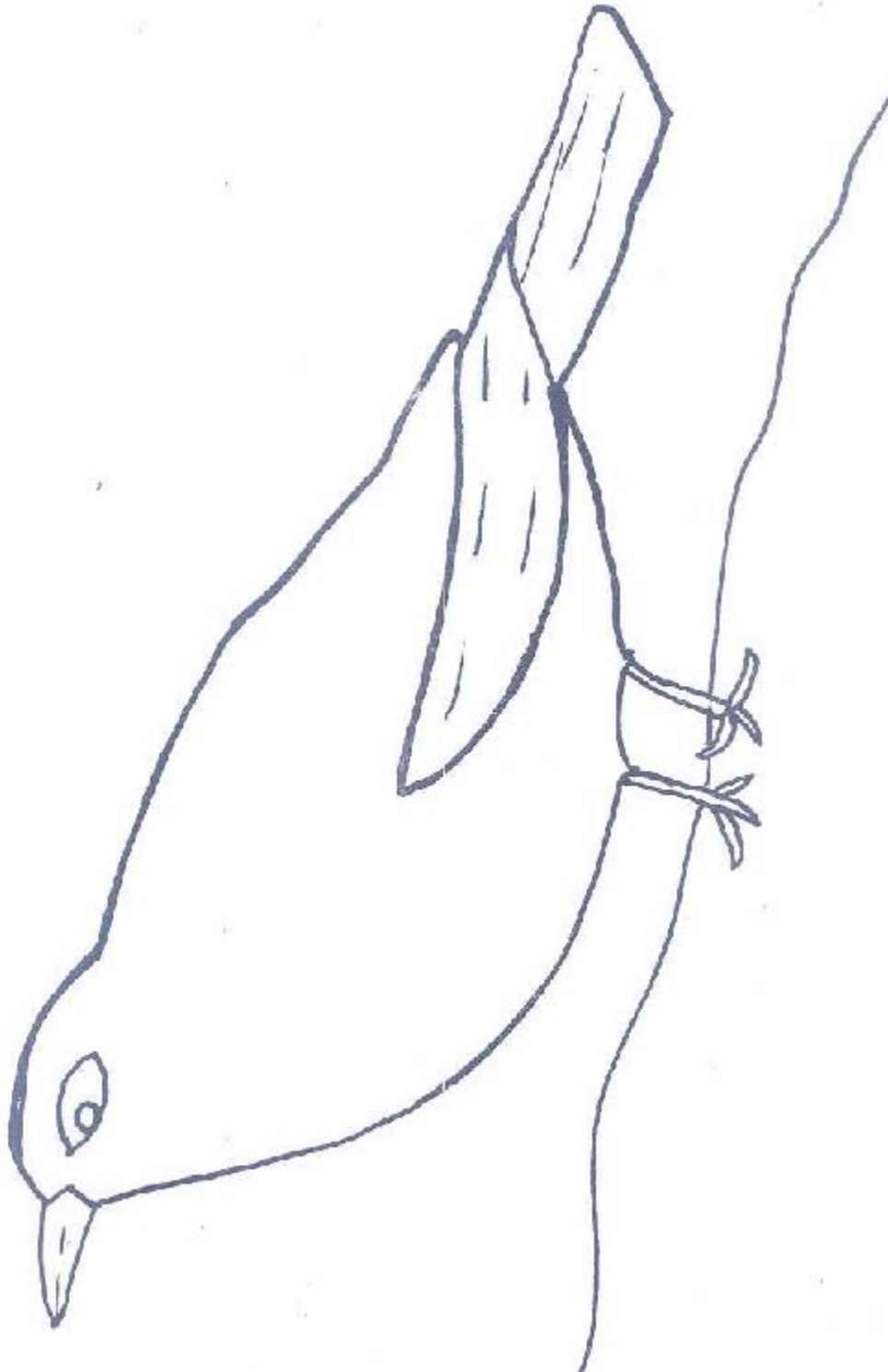

NAME:

DATE:



NAME:

DATE:

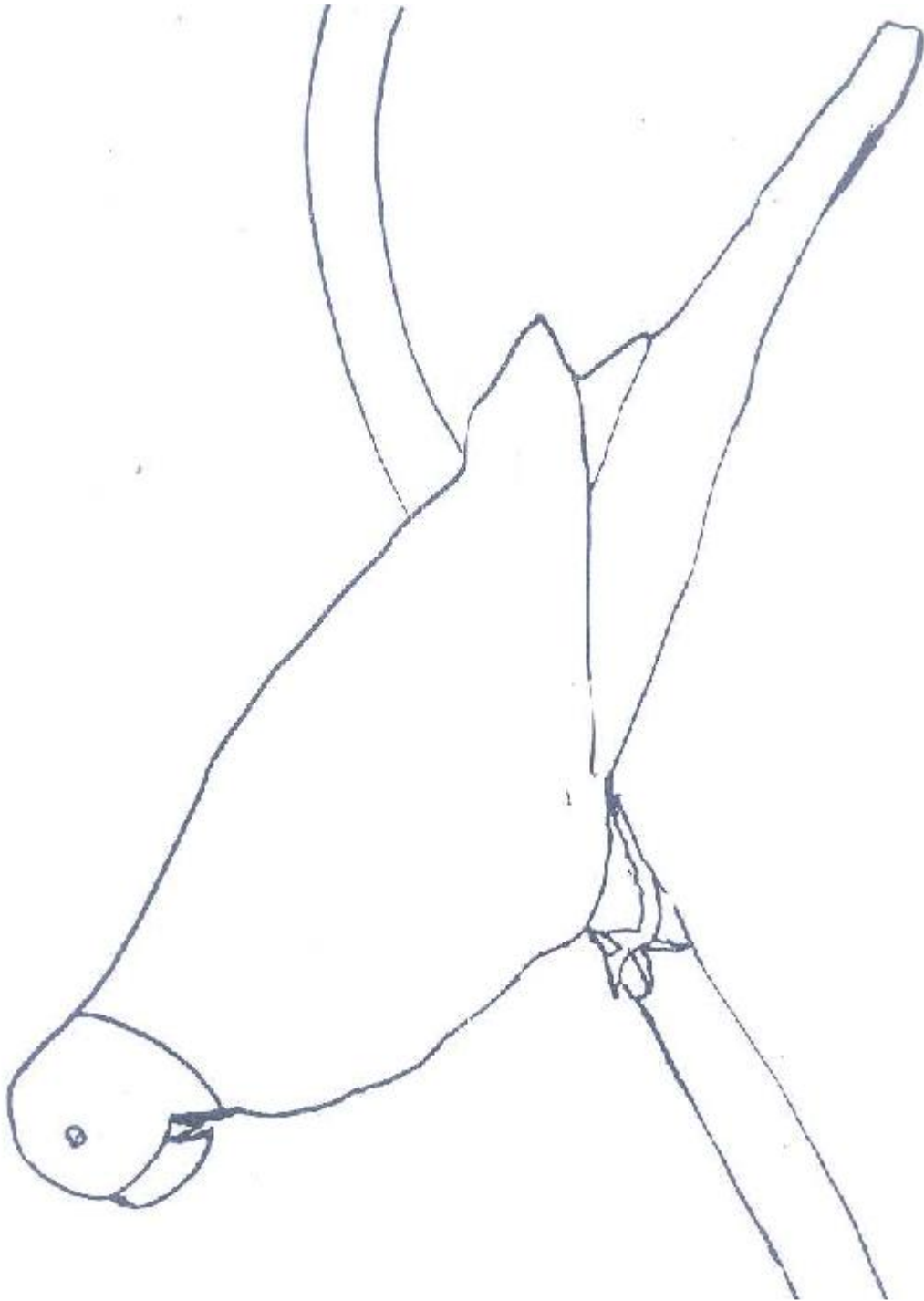

NAME:

DATE:

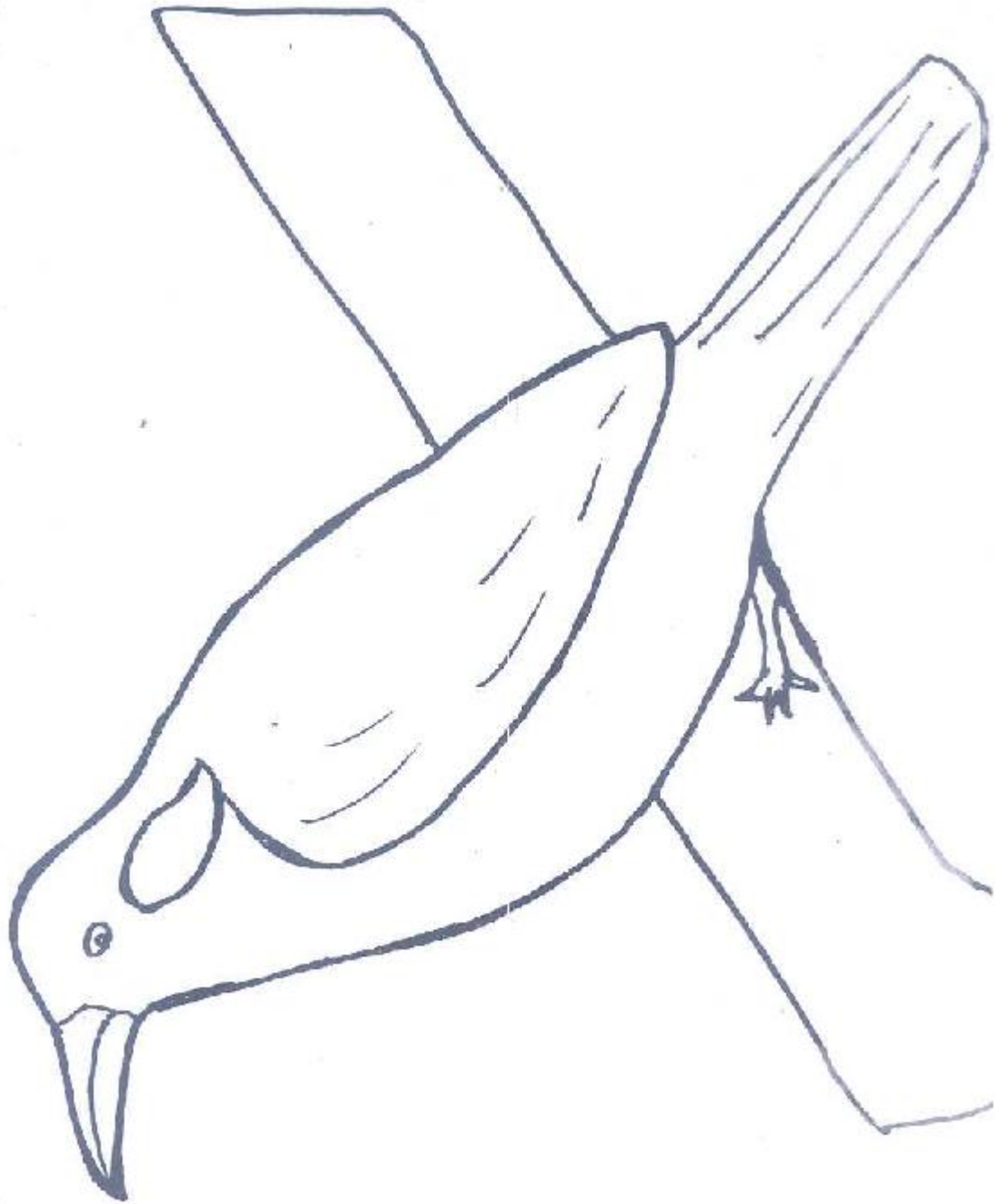

NAME:

DATE:

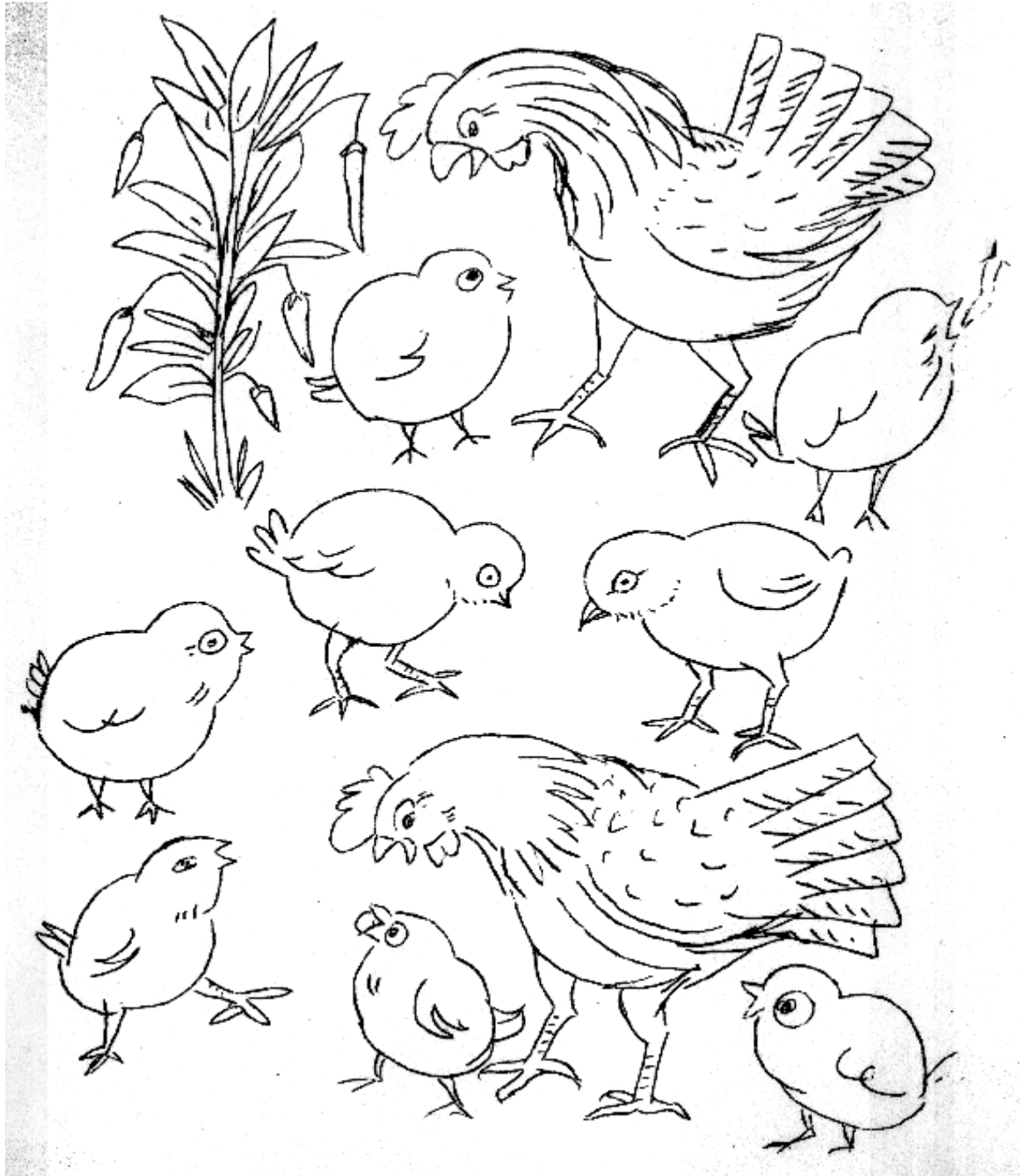

NAME:

DATE:

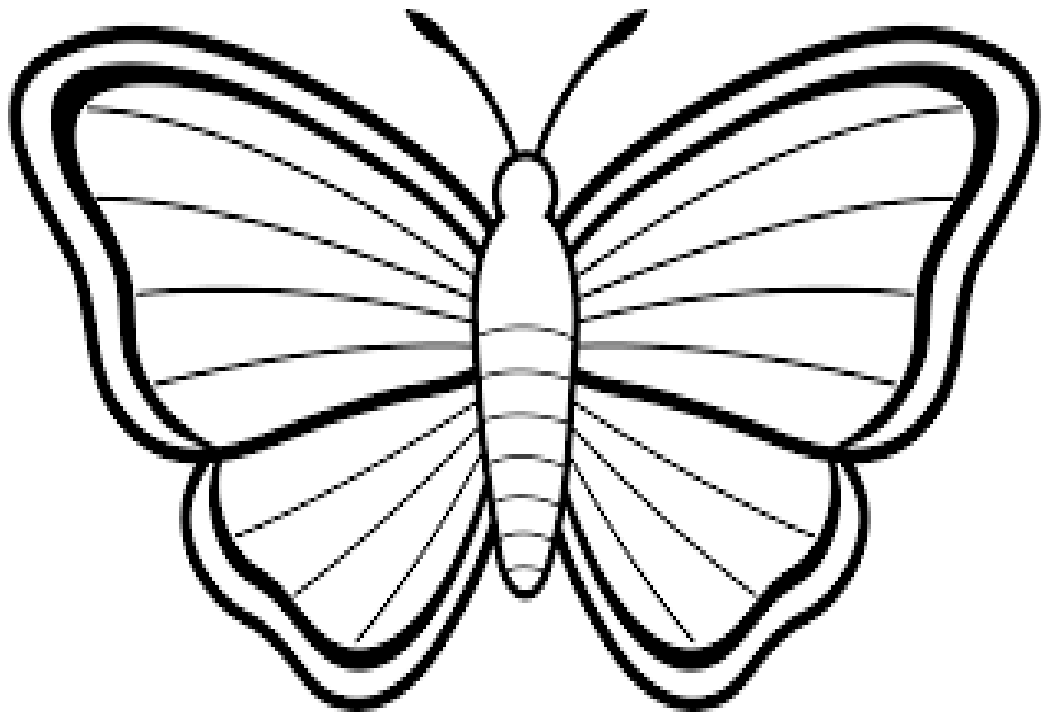

NAME:

DATE:

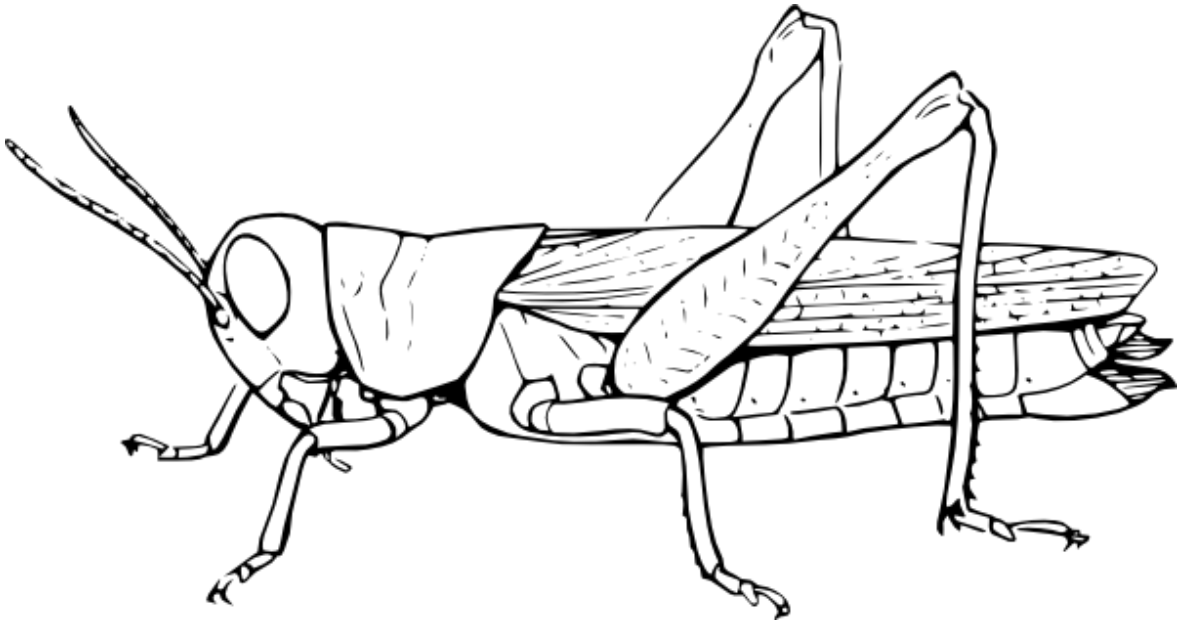

NAME:

DATE:

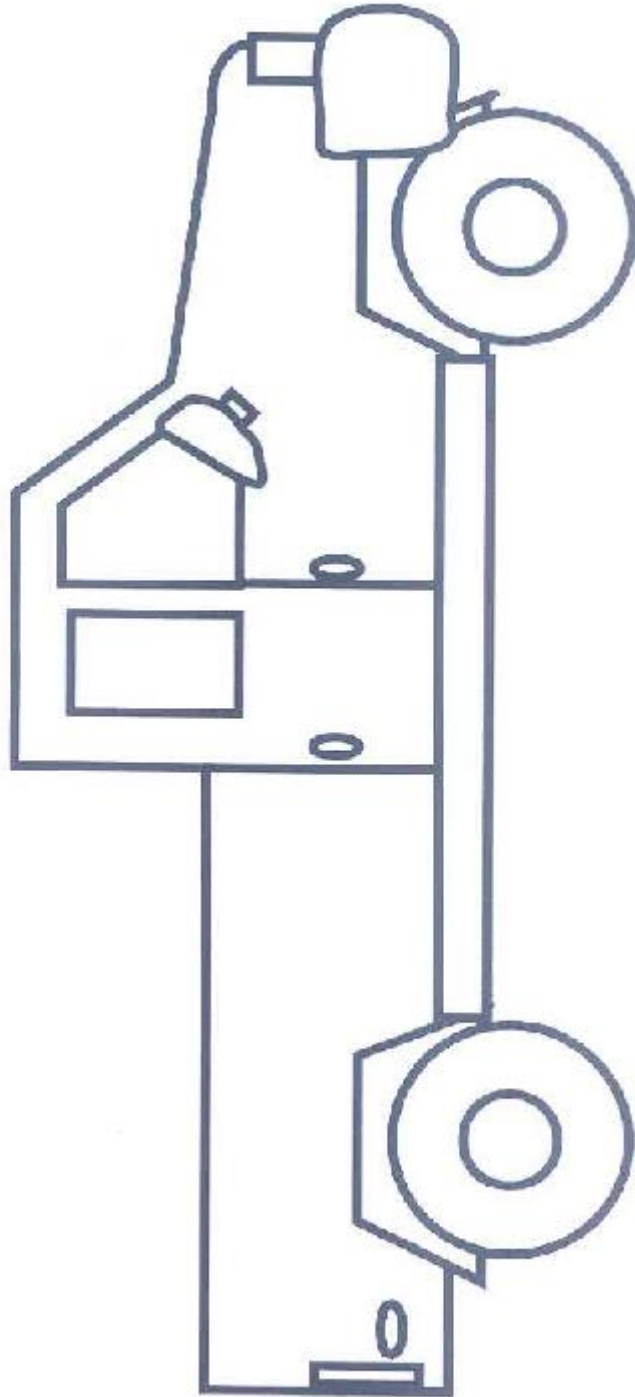

NAME:

DATE:

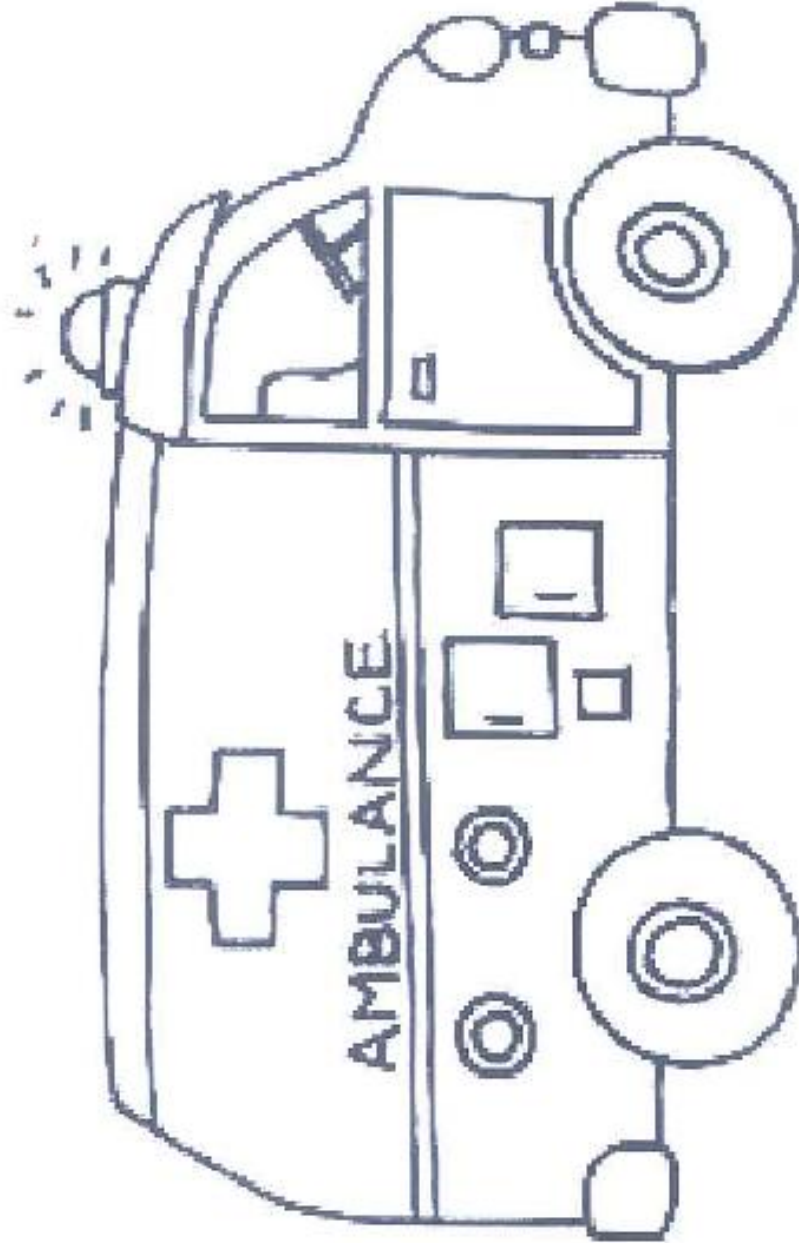

NAME:

DATE:

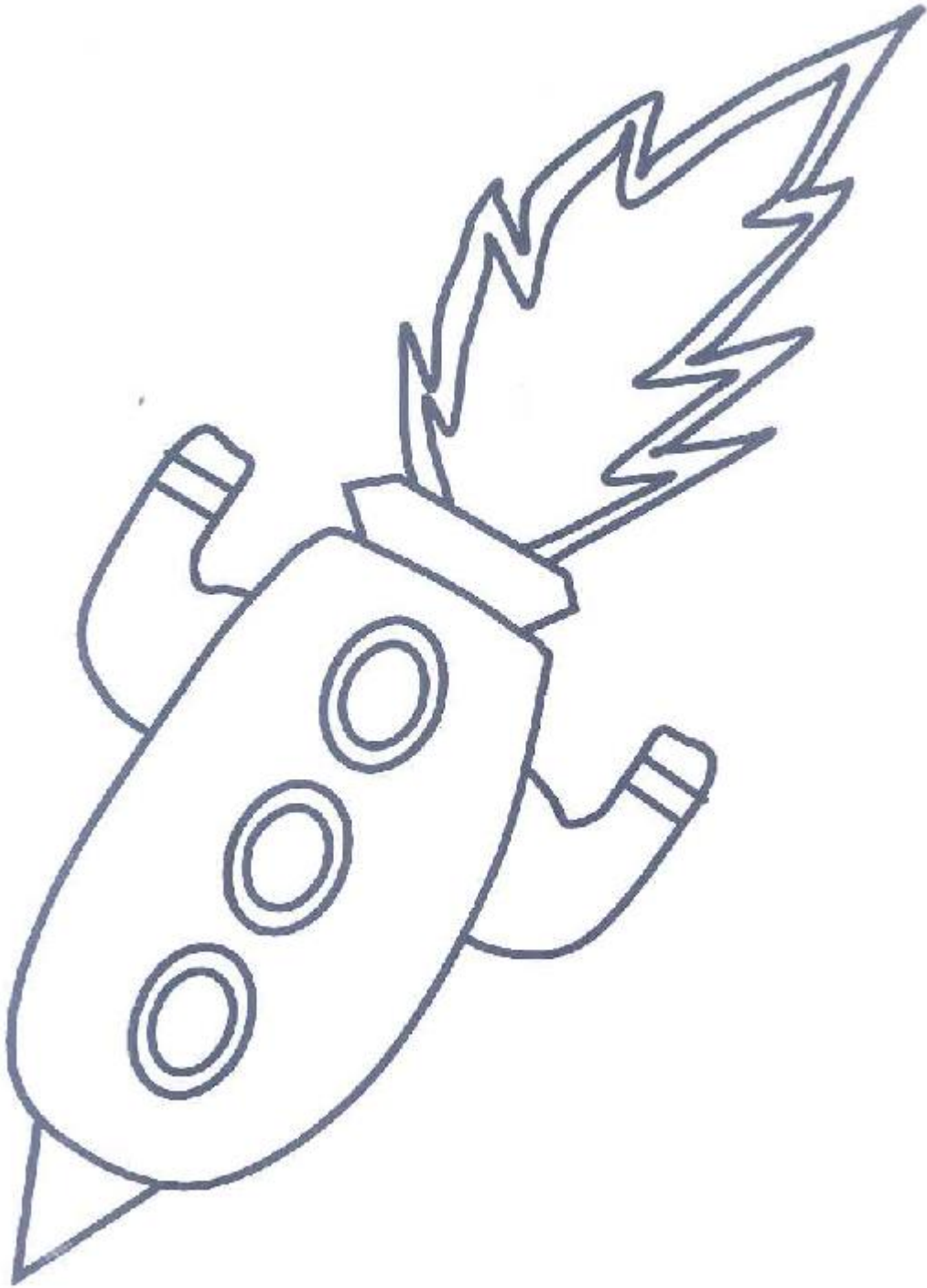

NAME:

DATE:

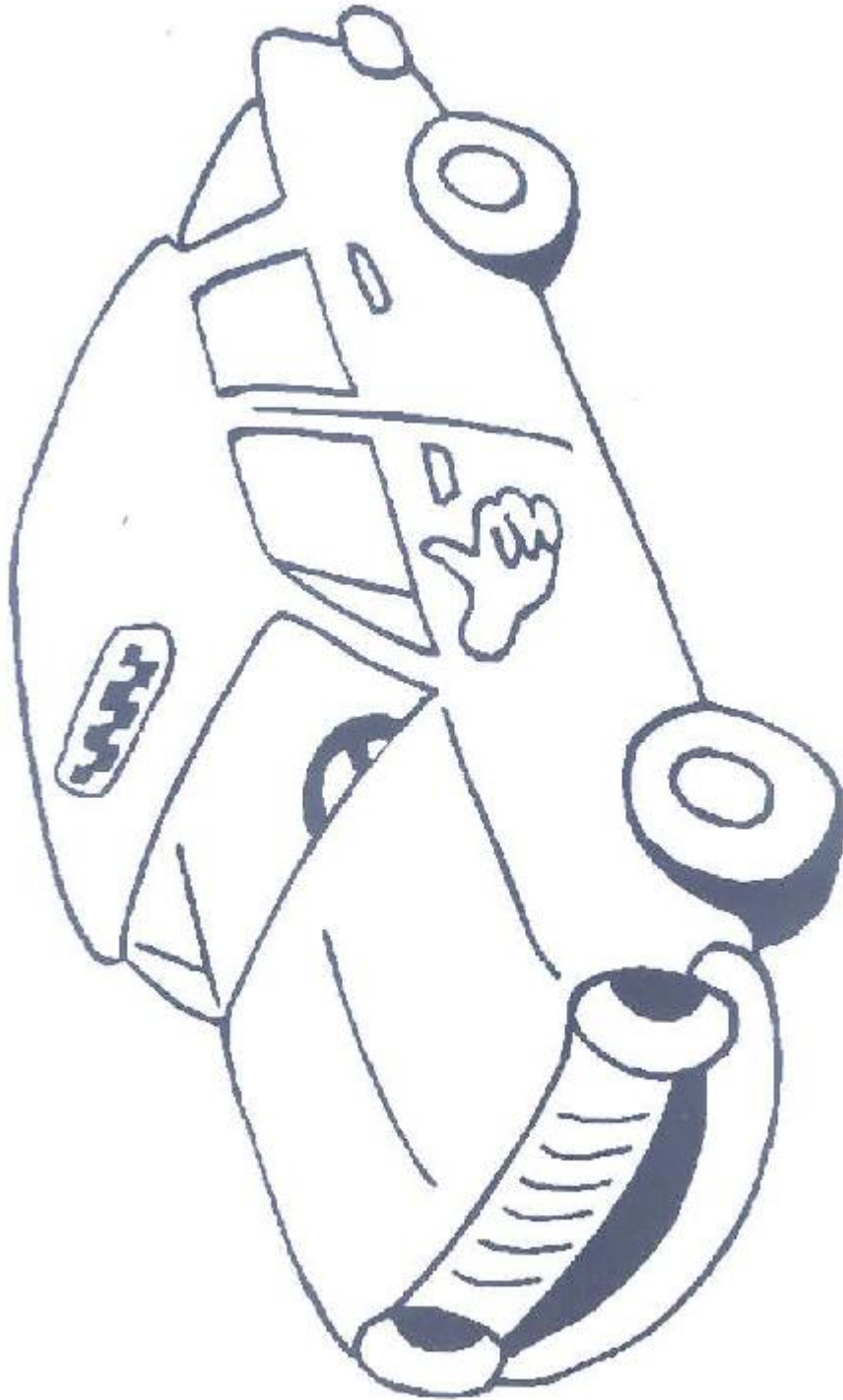

NAME:

DATE:

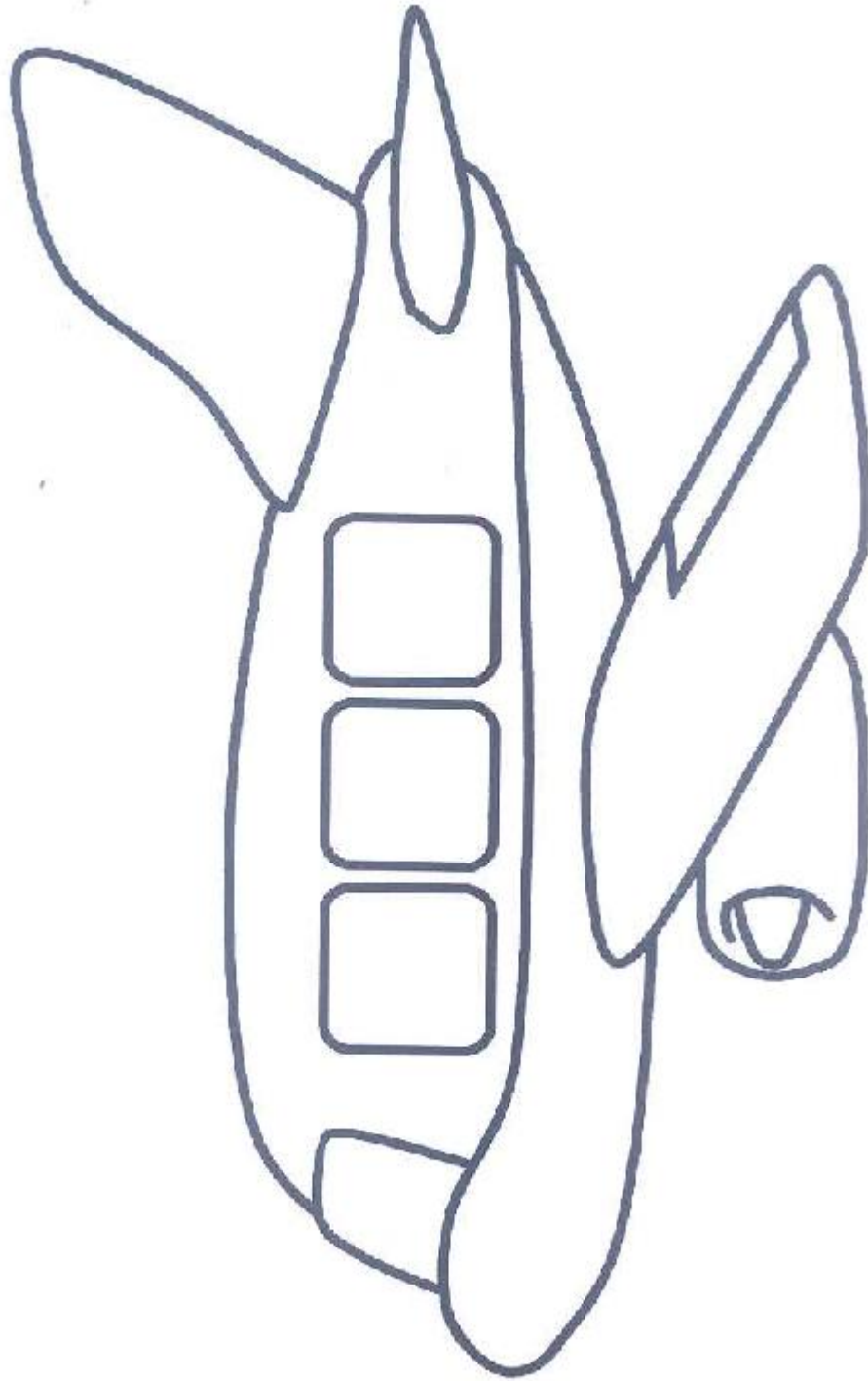

NAME:

DATE:

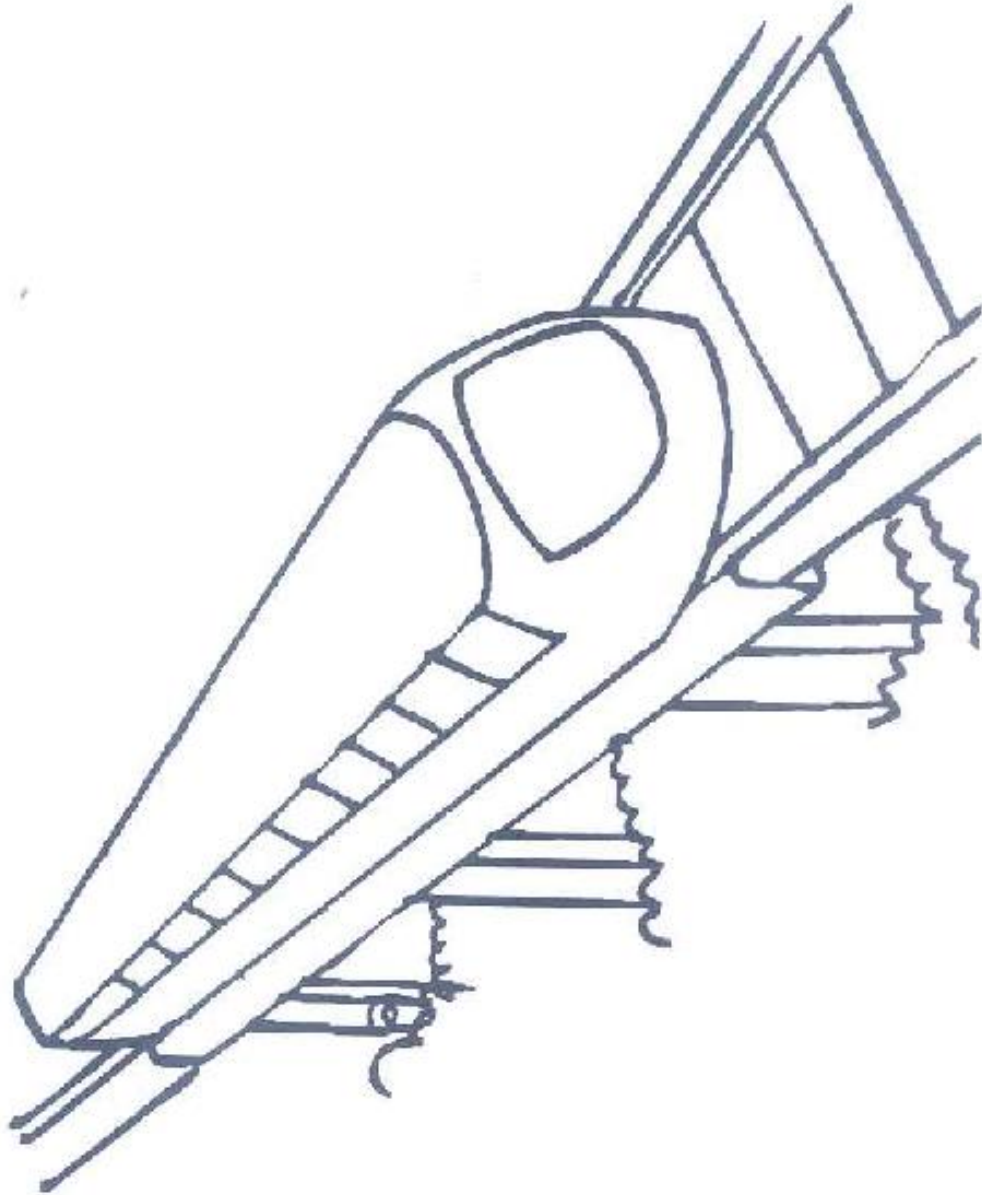

NAME:

DATE:

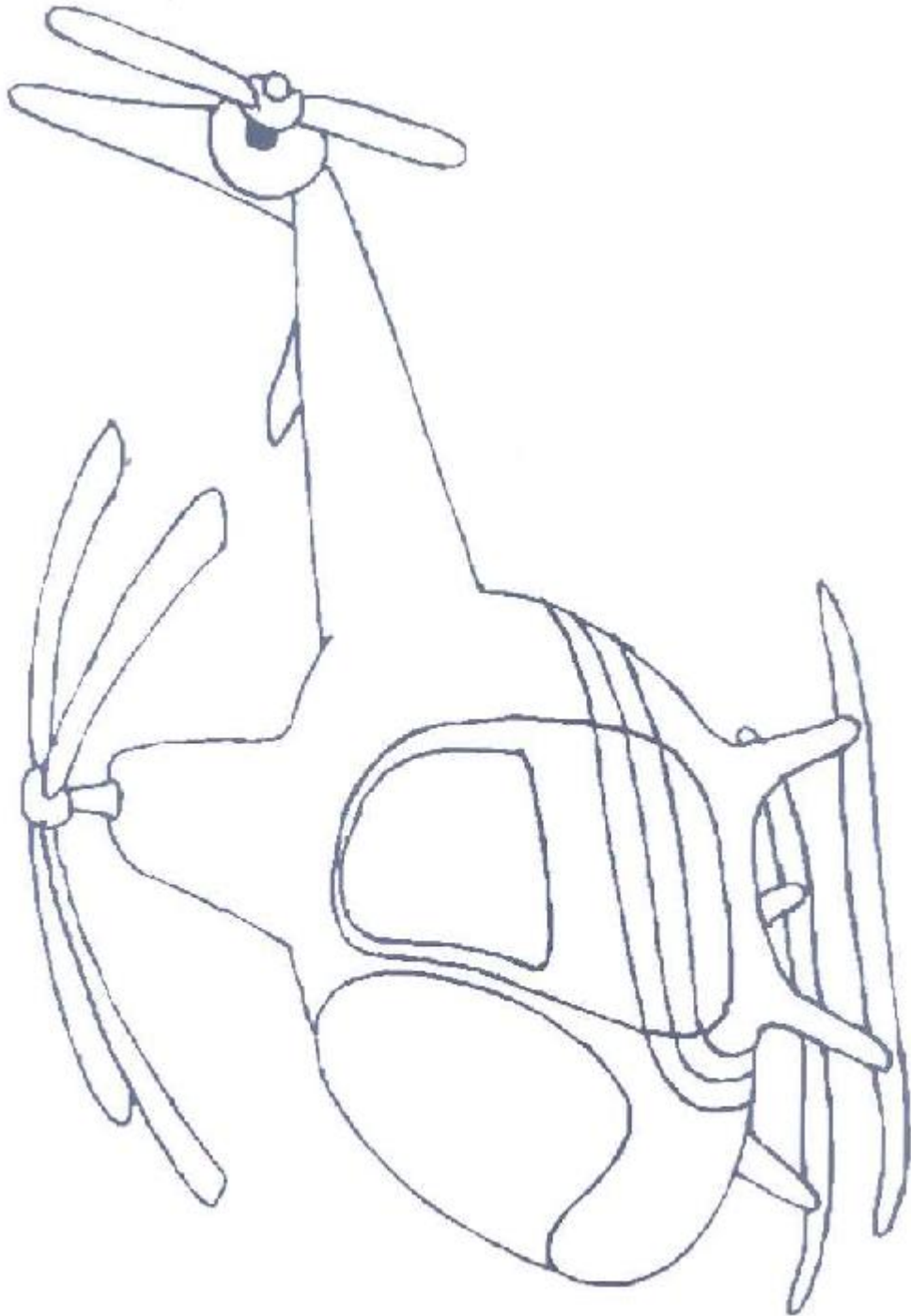

NAME:

DATE:

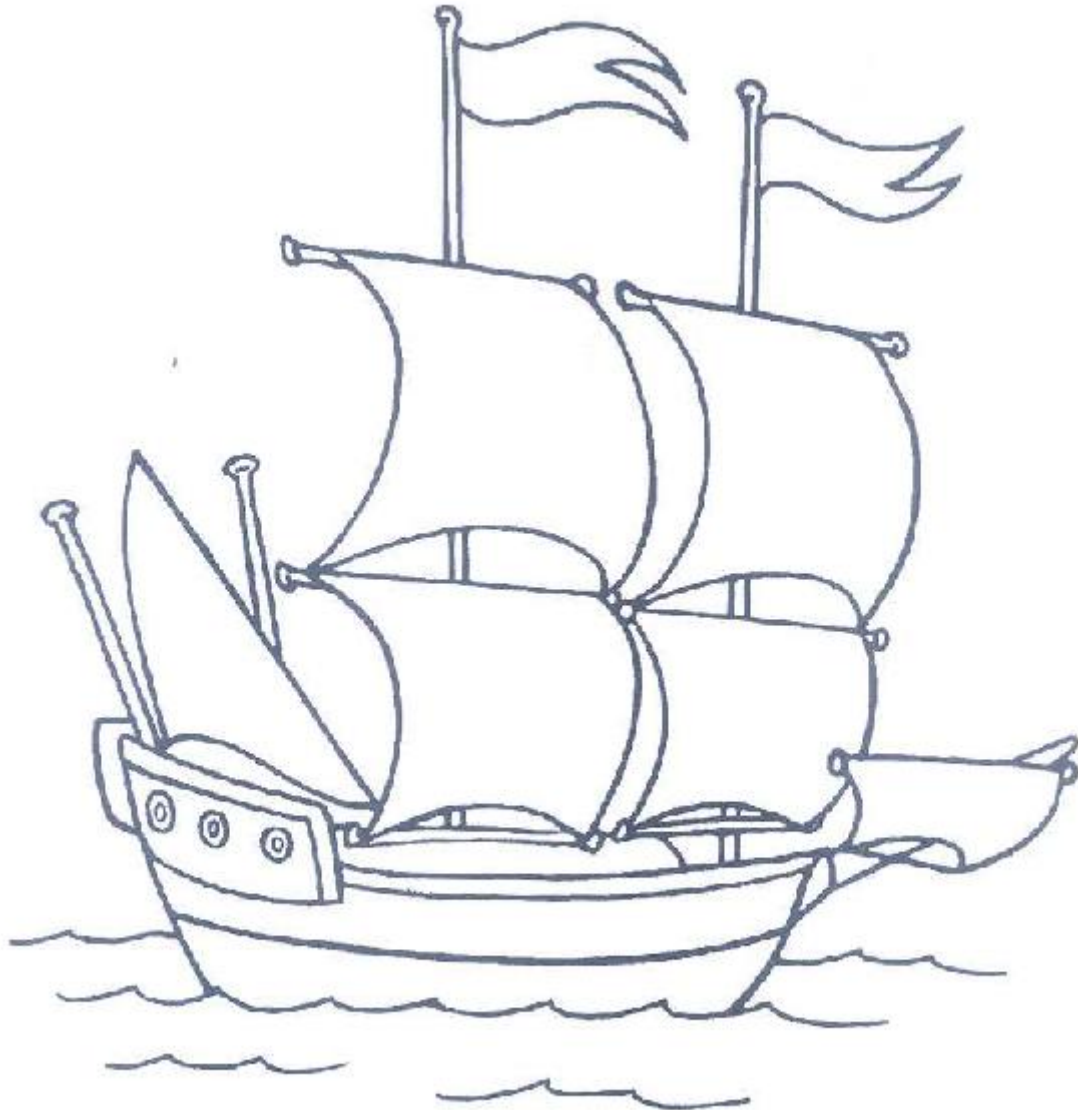

NAME:

DATE:



NAME:

DATE:

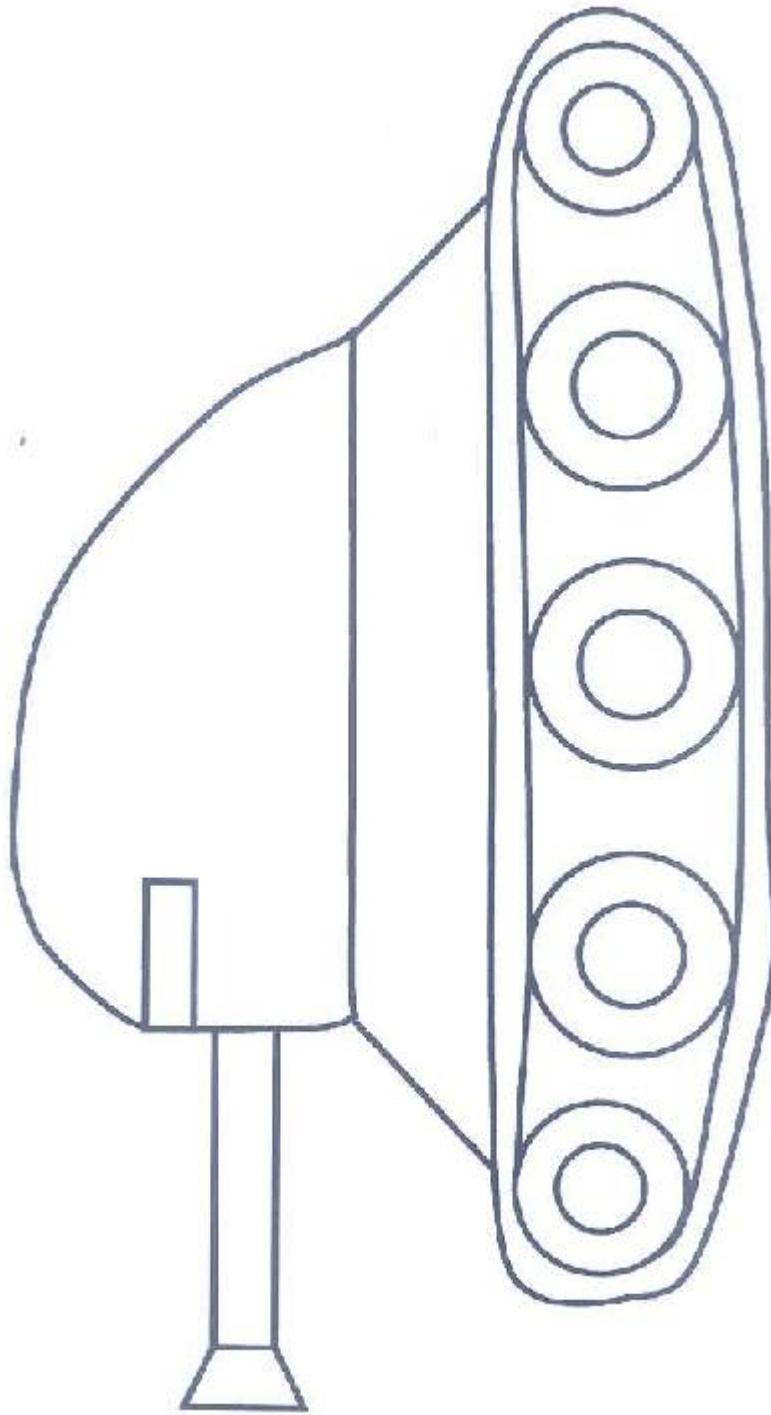

NAME:

DATE:

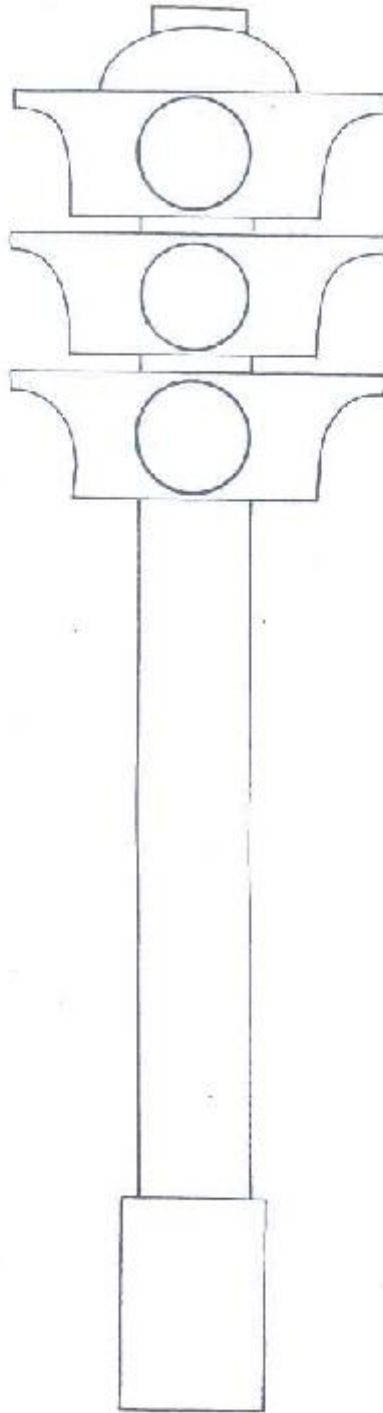

NAME:

DATE:

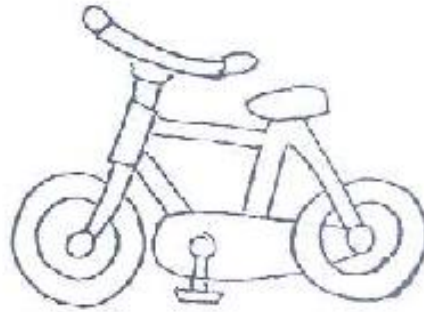

NAME:

DATE:

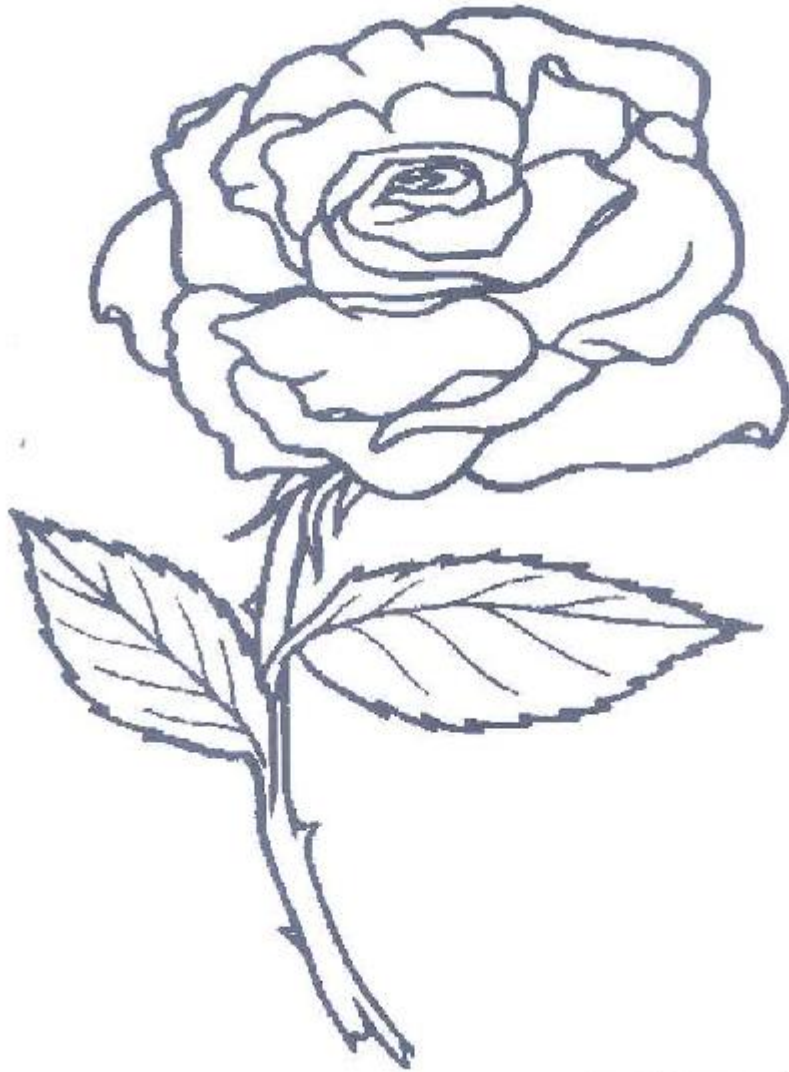

NAME:

DATE:

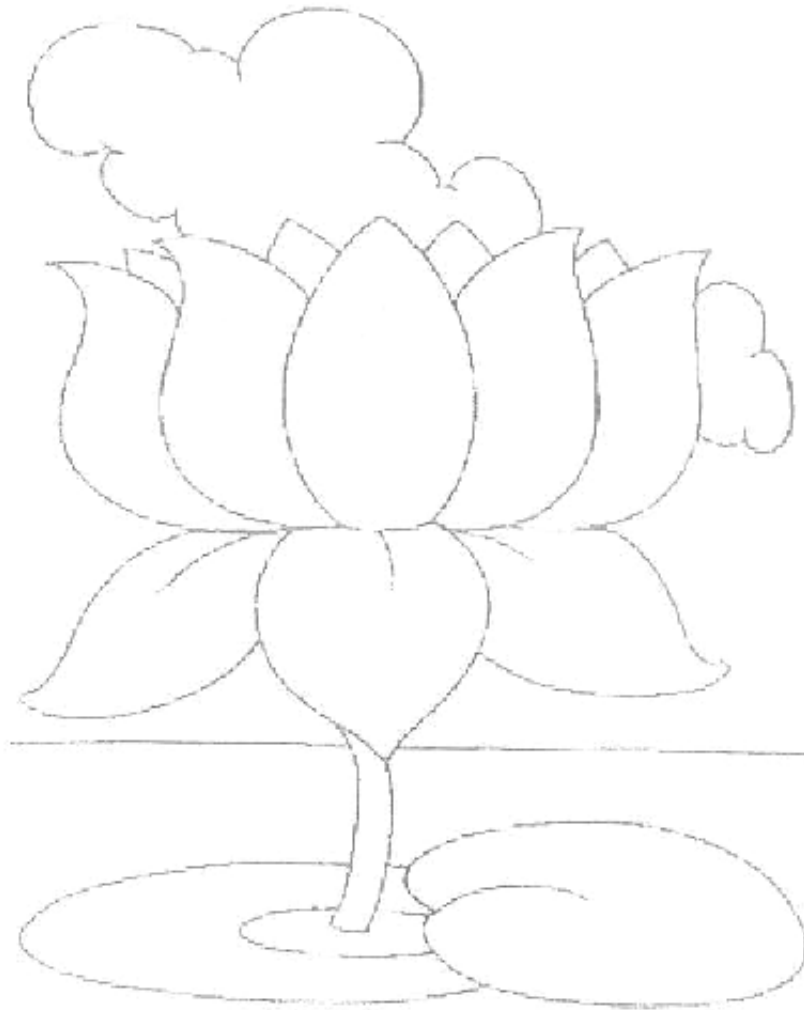

NAME:

DATE:

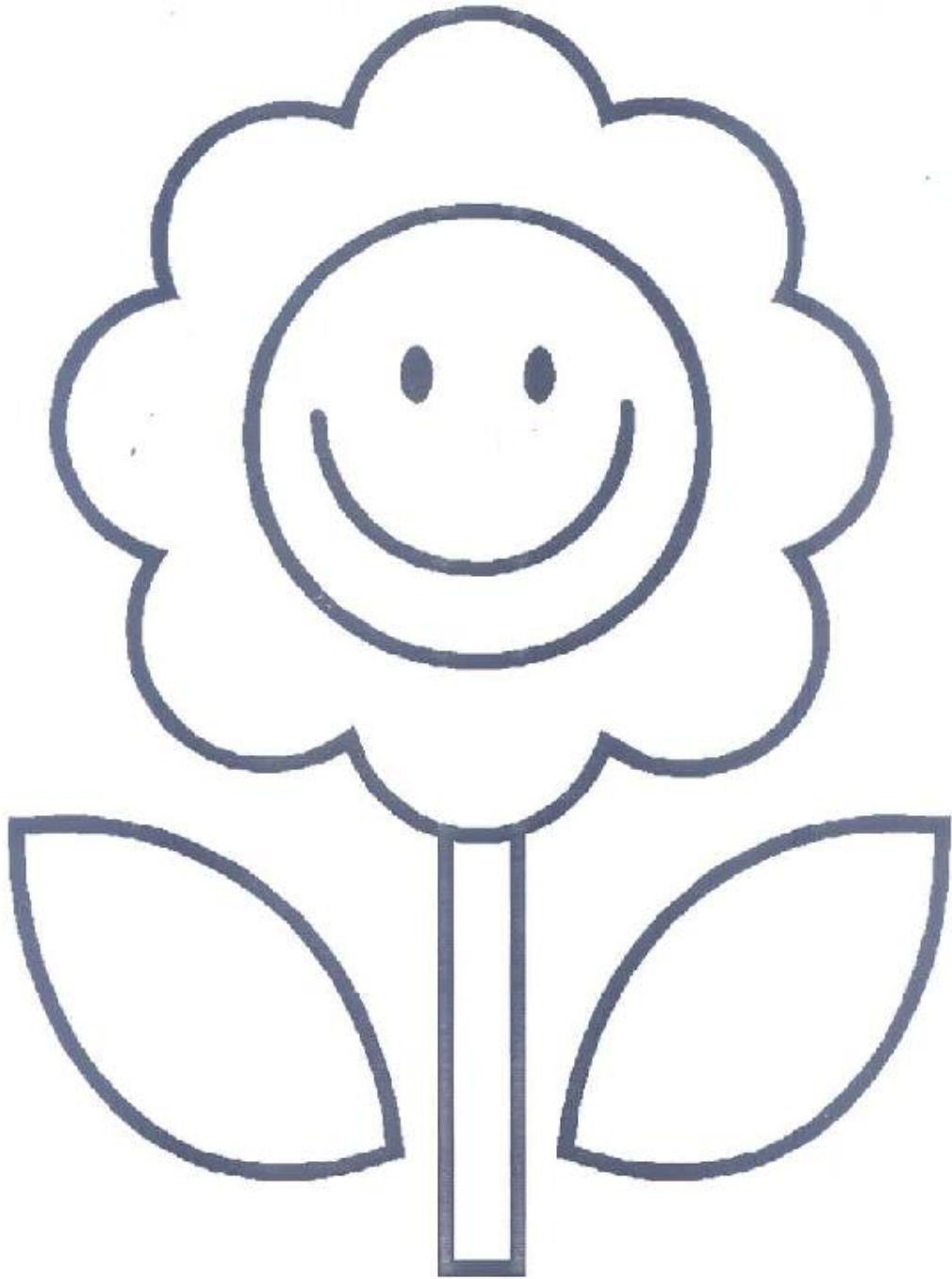

NAME:

DATE:

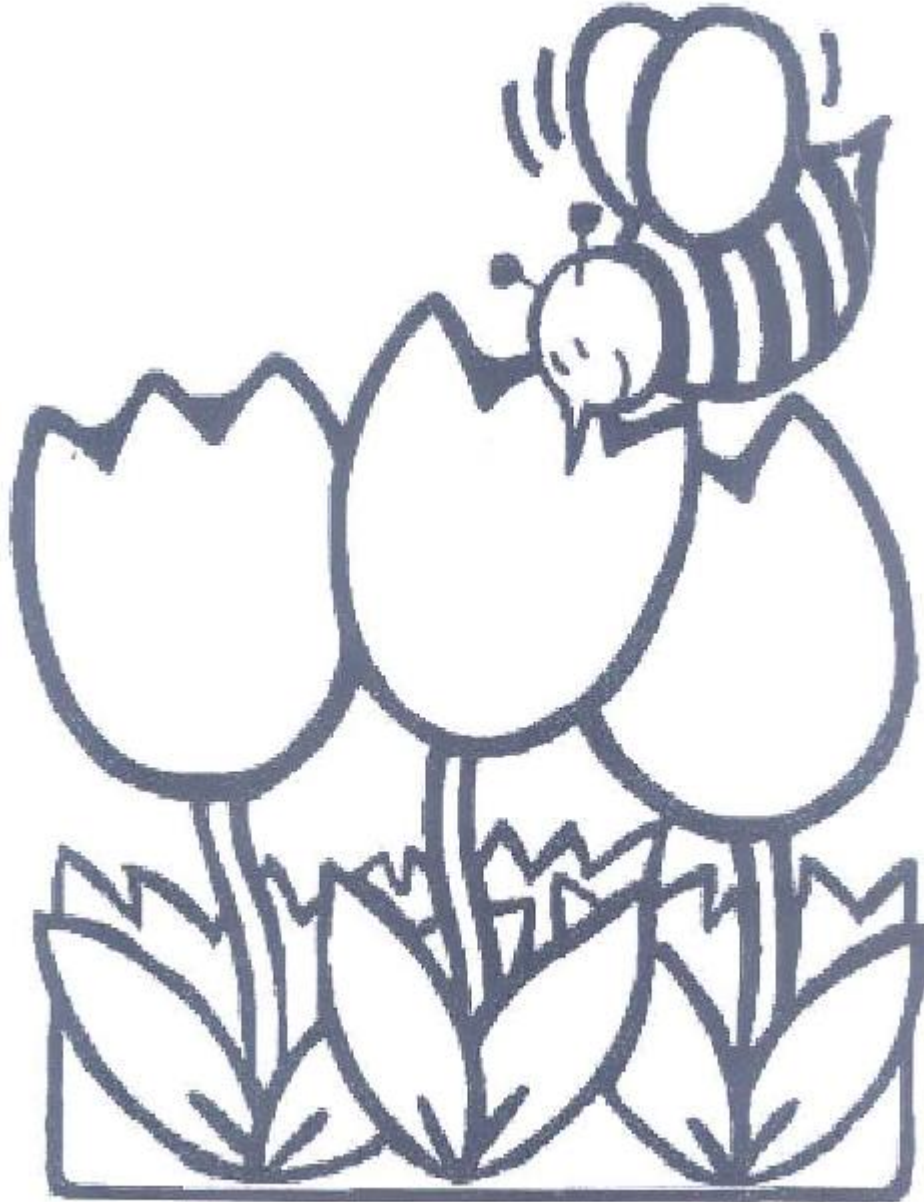

NAME:

DATE:

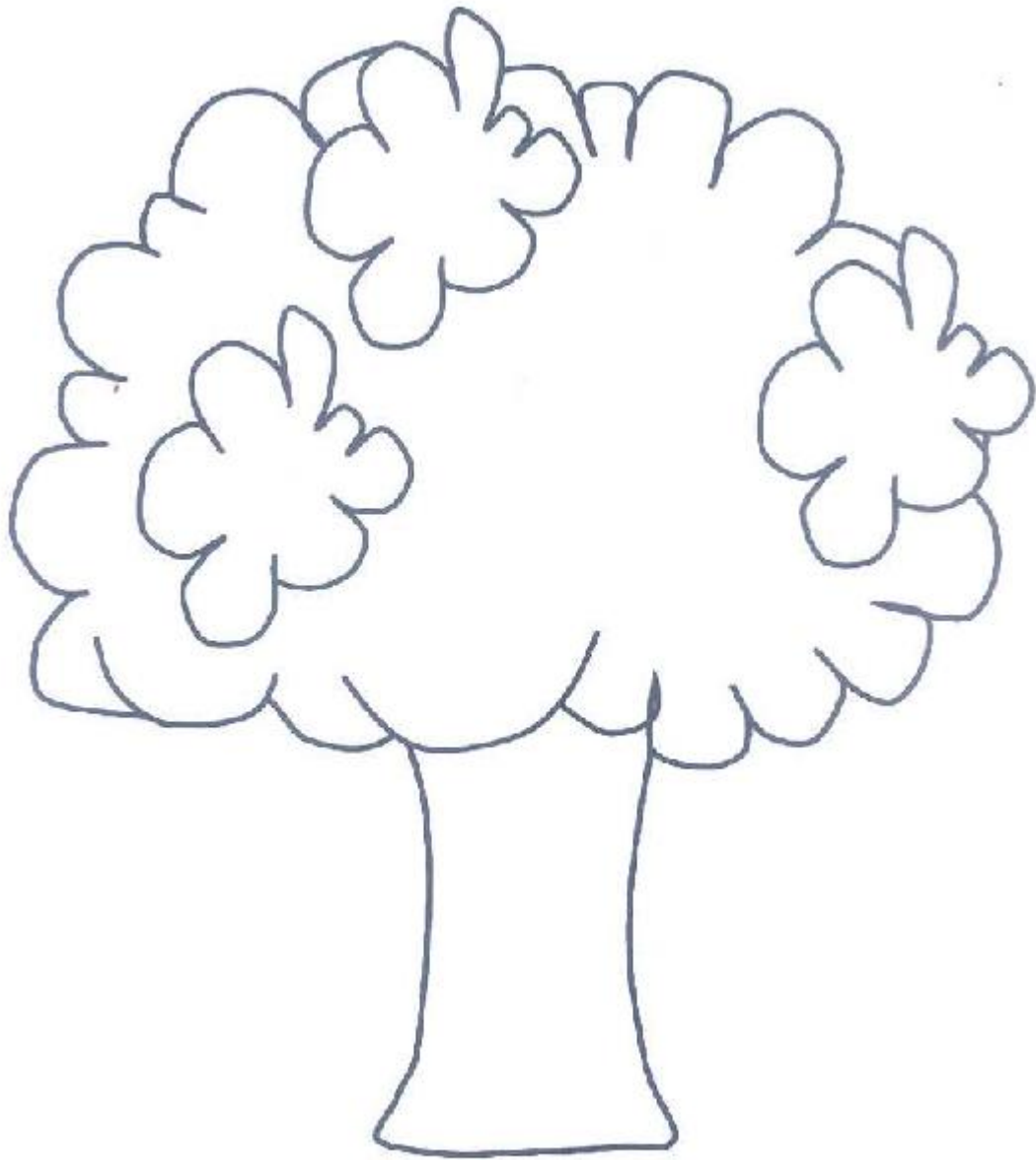

NAME:

DATE:



NAME:

DATE:

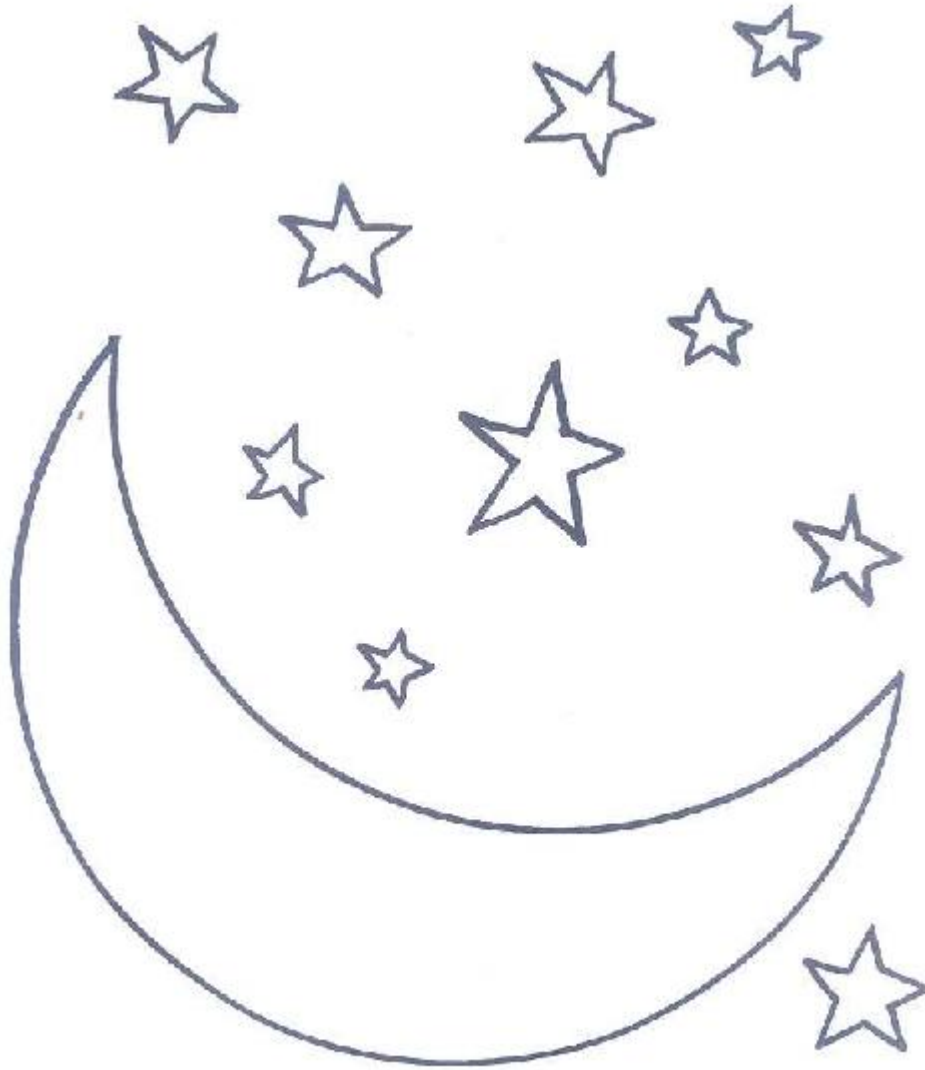

NAME:

DATE:



NAME:

DATE:



NAME:

DATE:



NAME:

DATE:



NAME:

DATE:



NAME:

DATE:



NAME:

DATE:



NAME:

DATE:



NAME:

DATE:



NAME:

DATE:



NAME:

DATE:



NAME:

DATE:



NAME:

DATE:

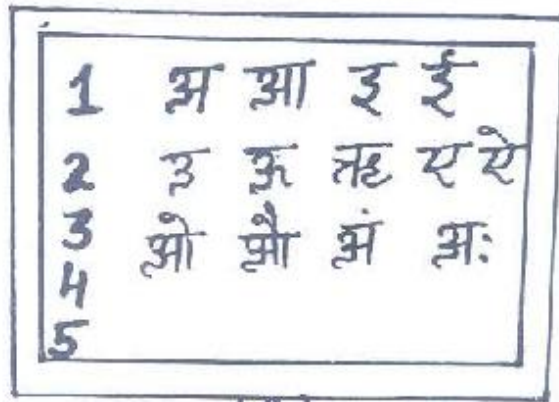

NAME:

DATE:

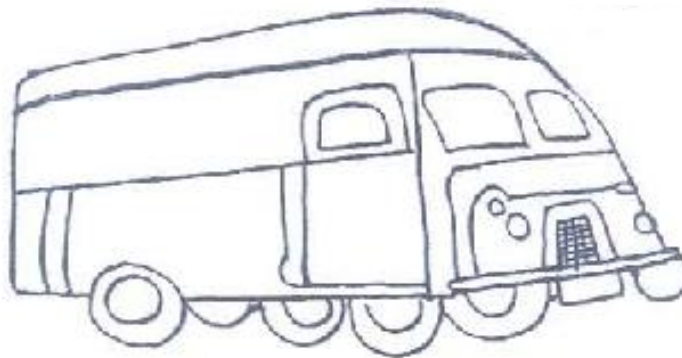
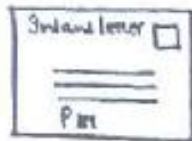
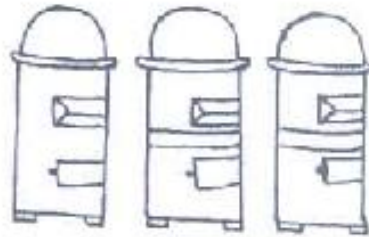

NAME:

DATE:



NAME:

DATE:

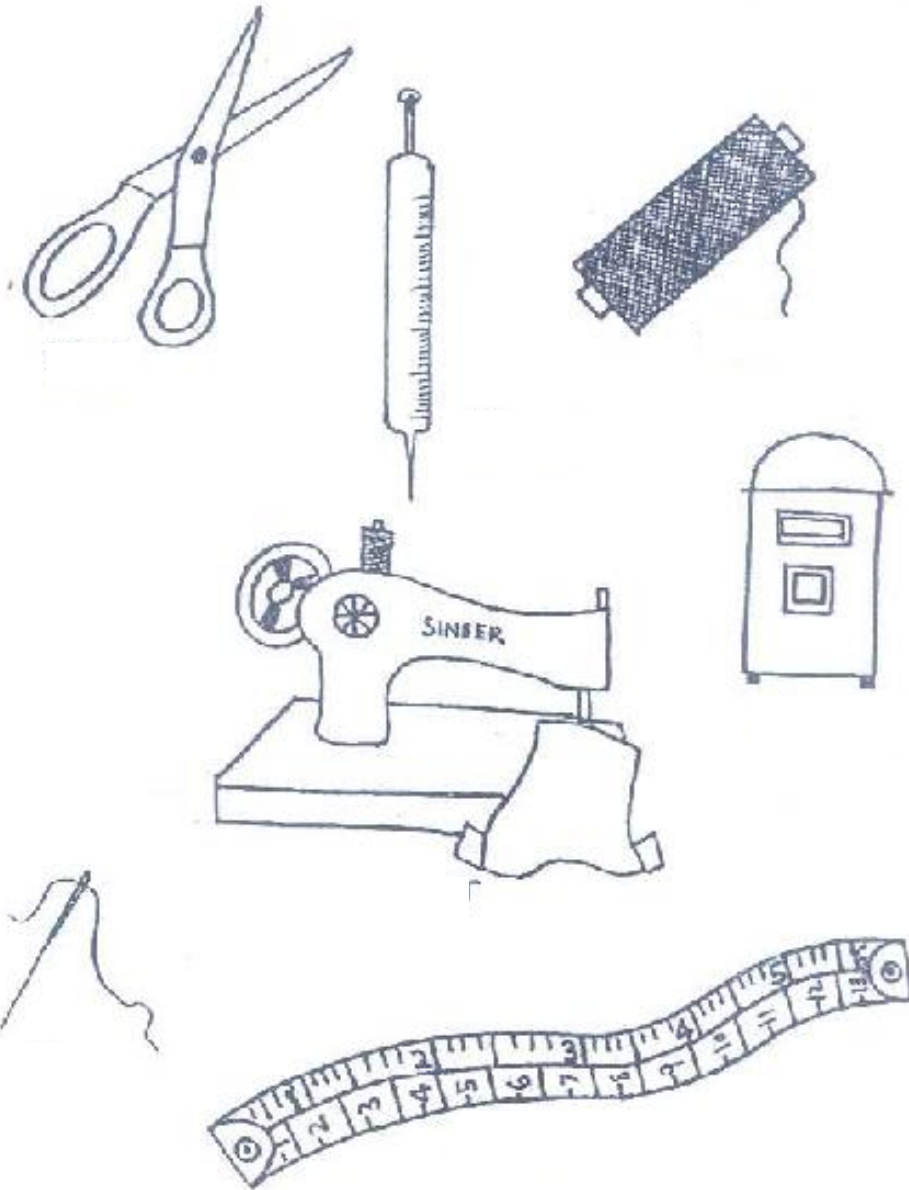

NAME:

DATE:

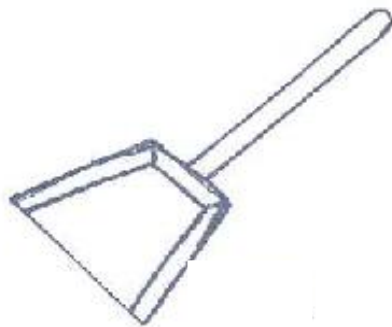
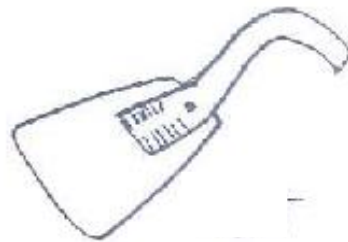
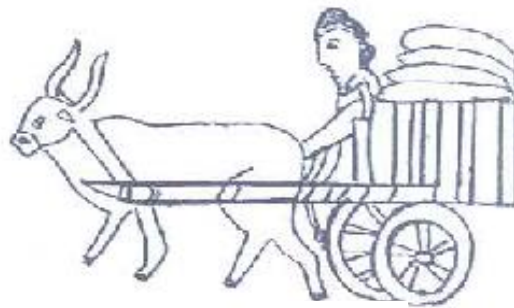

NAME:

DATE:

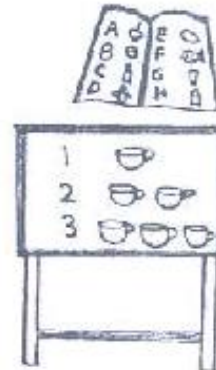

NAME:

DATE:



NAME:

DATE:

Worksheets for Cognitive Development

NAME:

DATE:

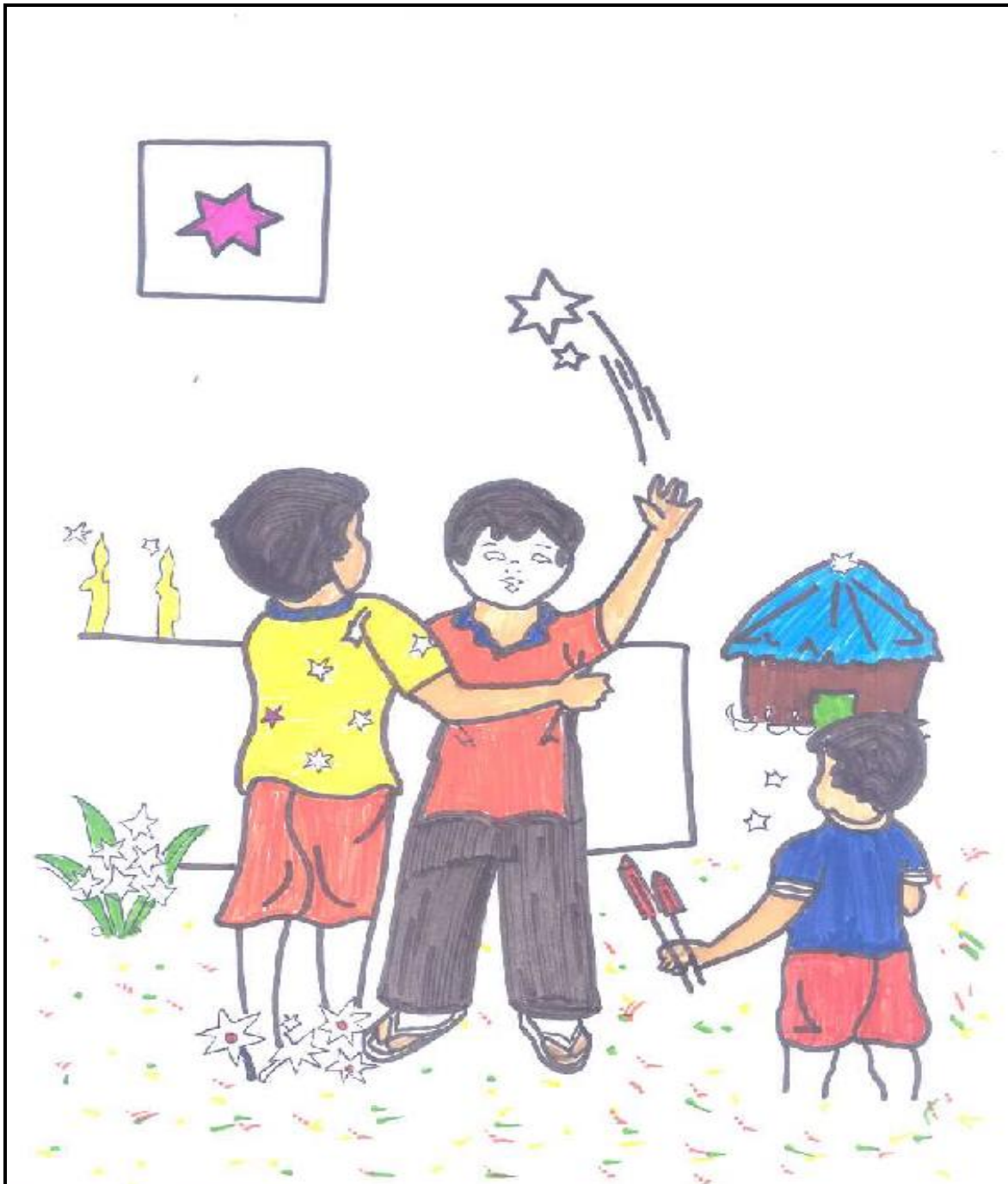

NAME:

DATE:



NAME:

DATE:



NAME:

DATE:



NAME:

DATE:

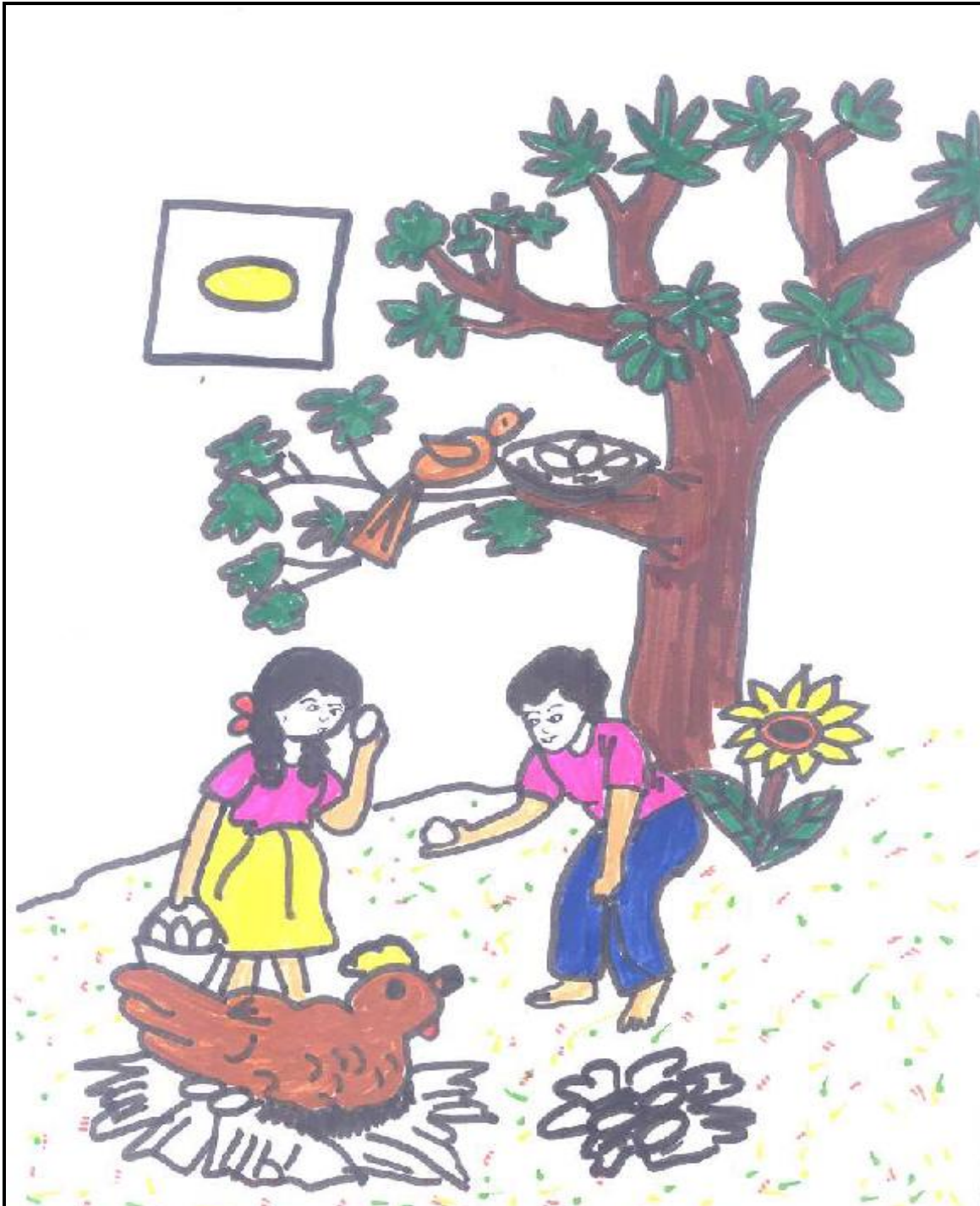

NAME:

DATE:

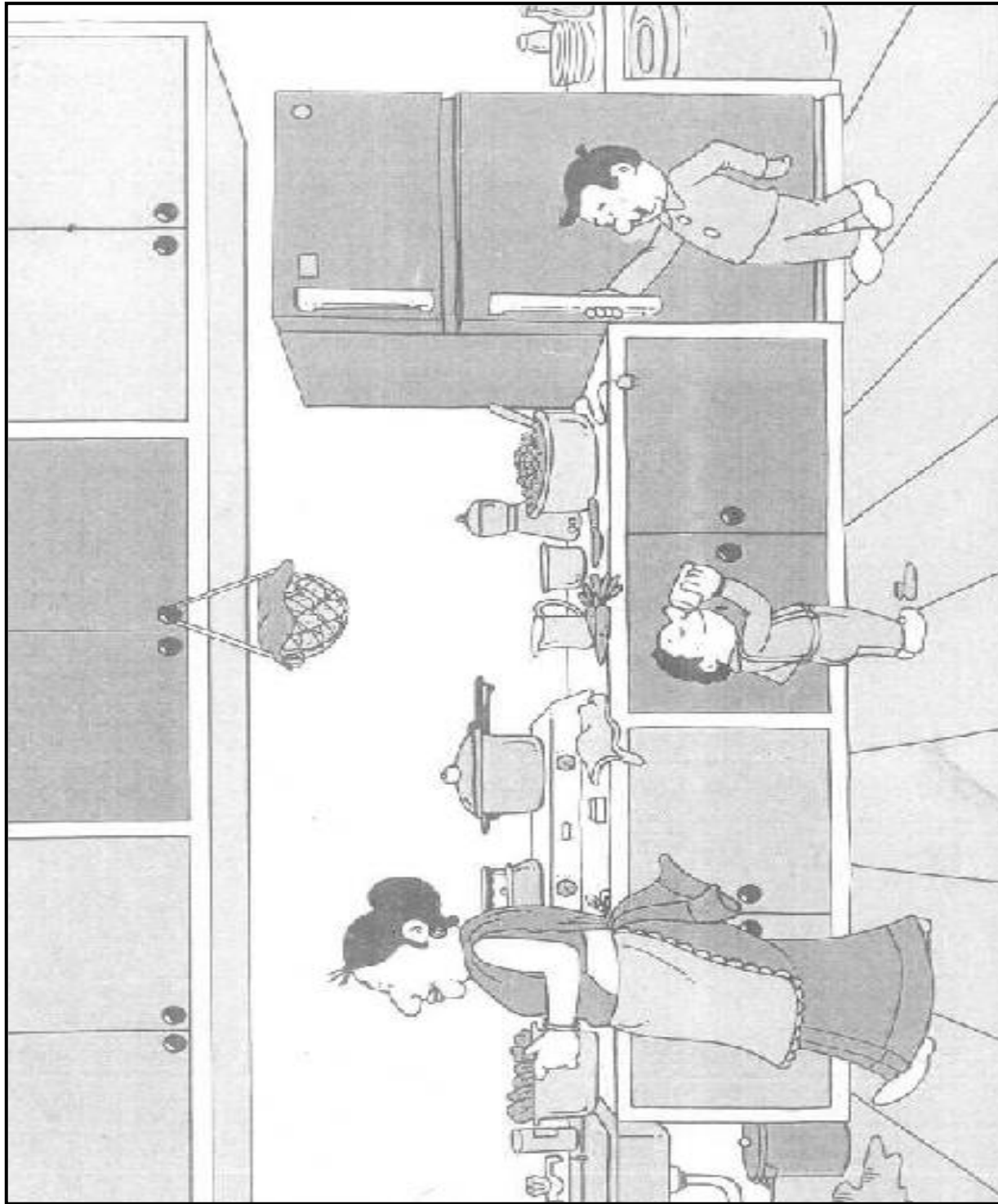

NAME:

DATE:

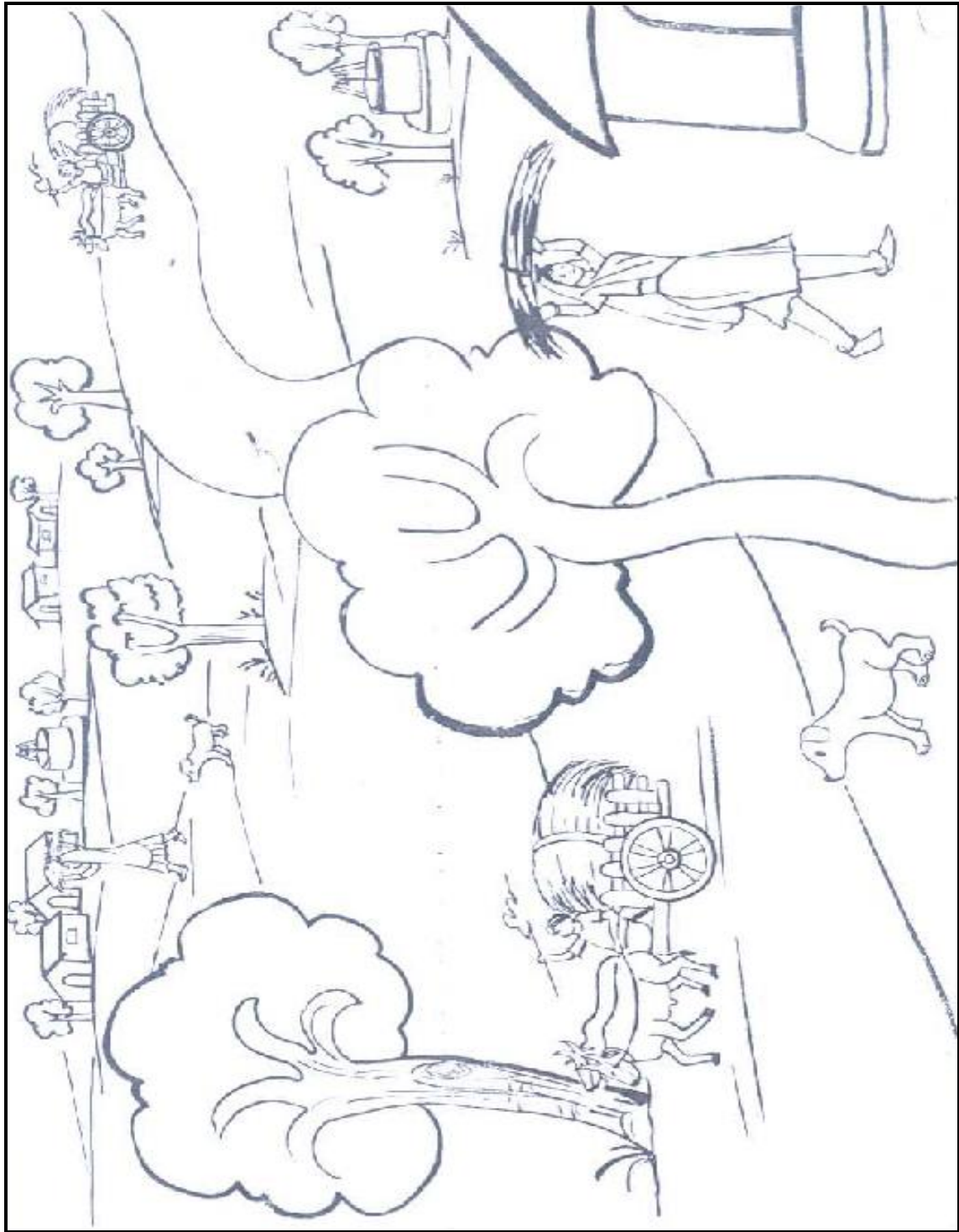

NAME:

DATE:

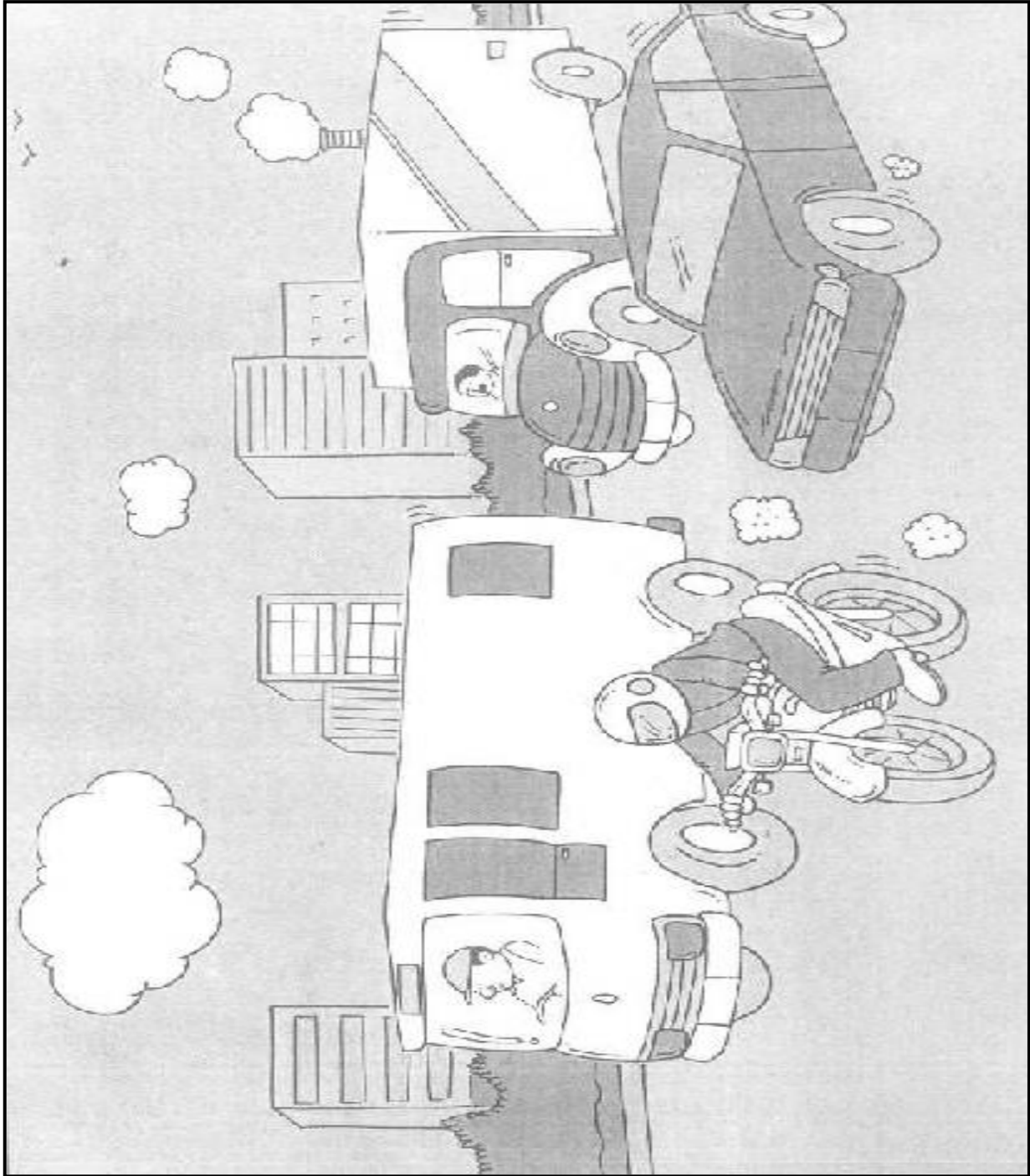

NAME:

DATE:

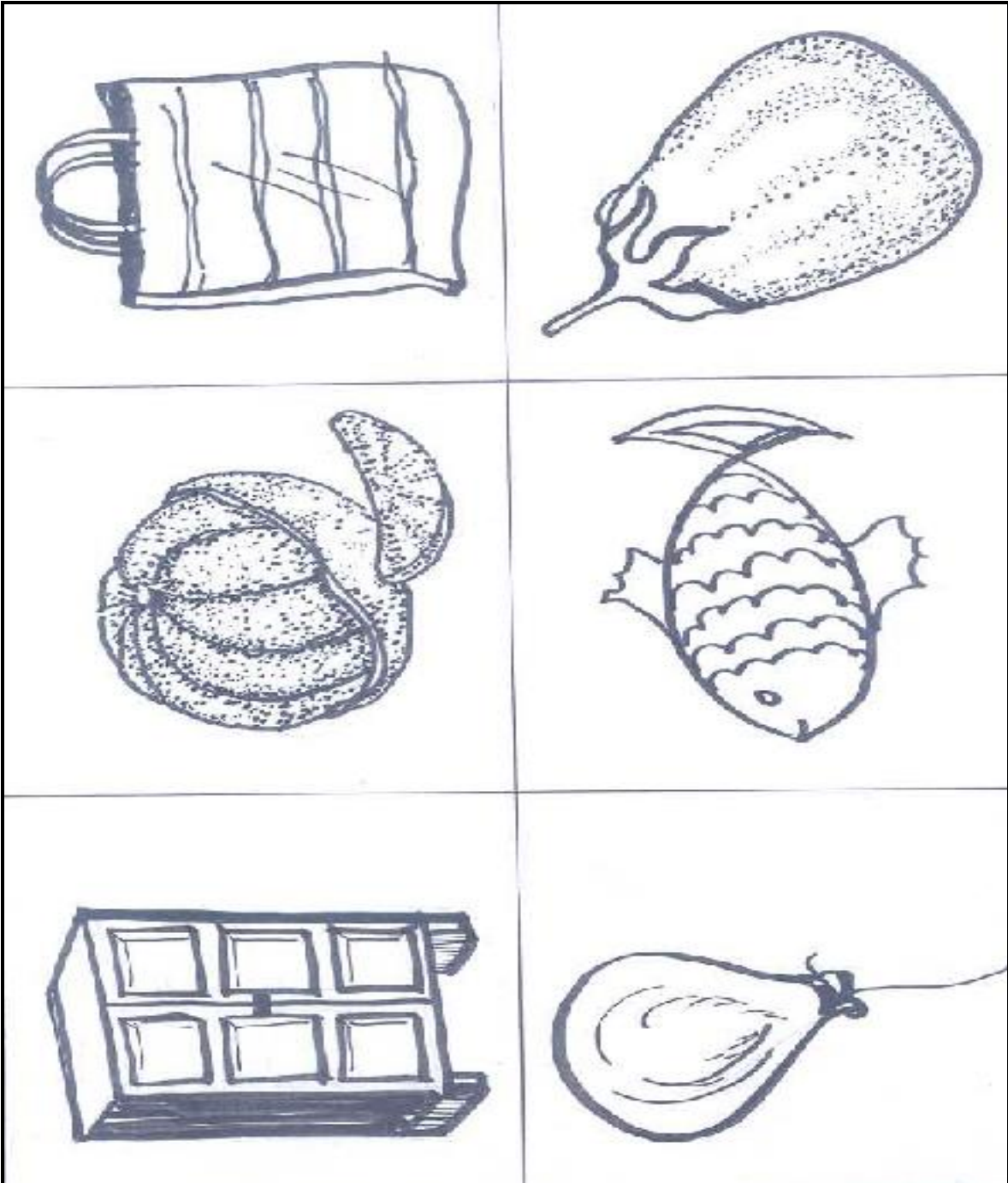

NAME:

DATE:

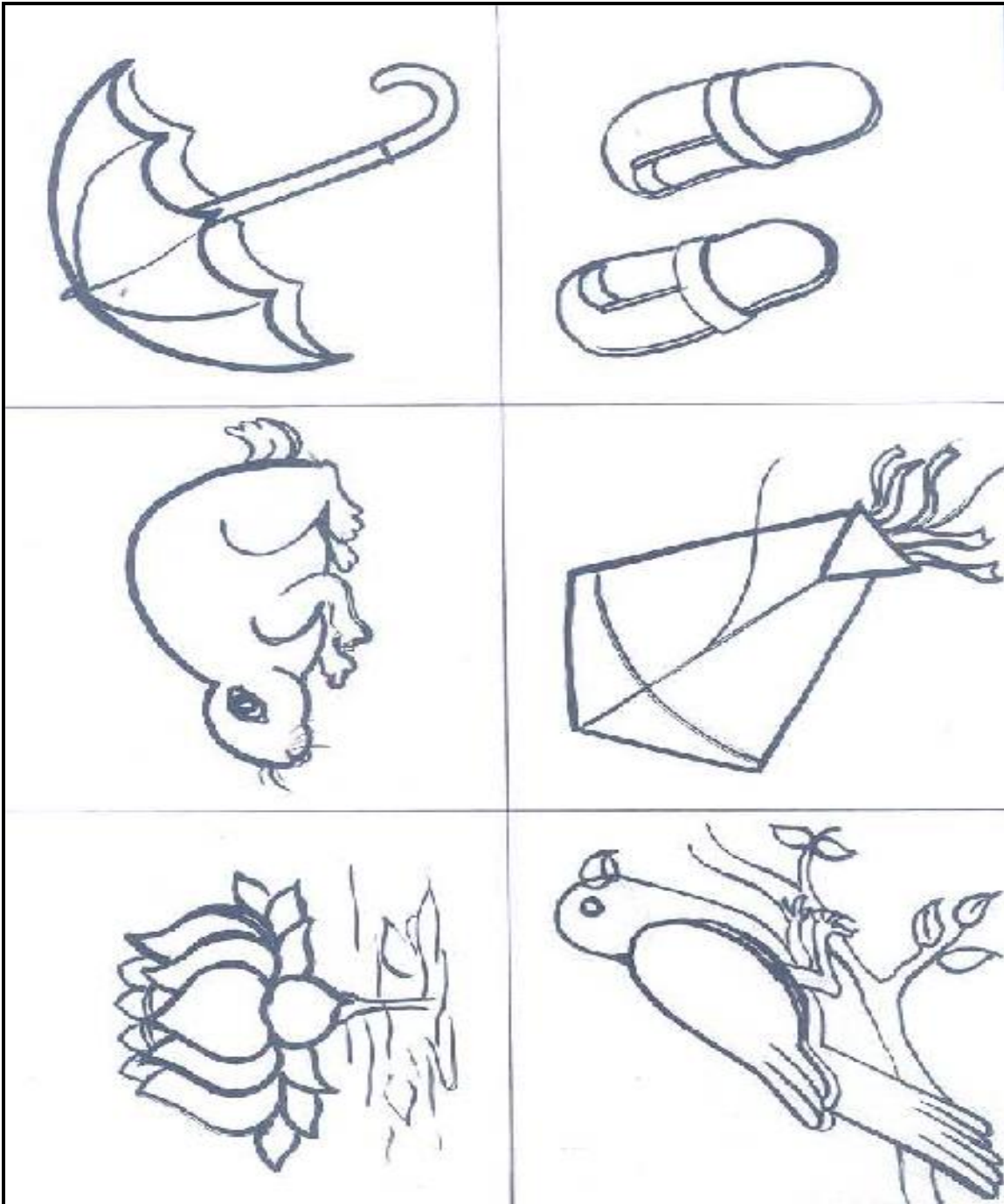

NAME:

DATE:

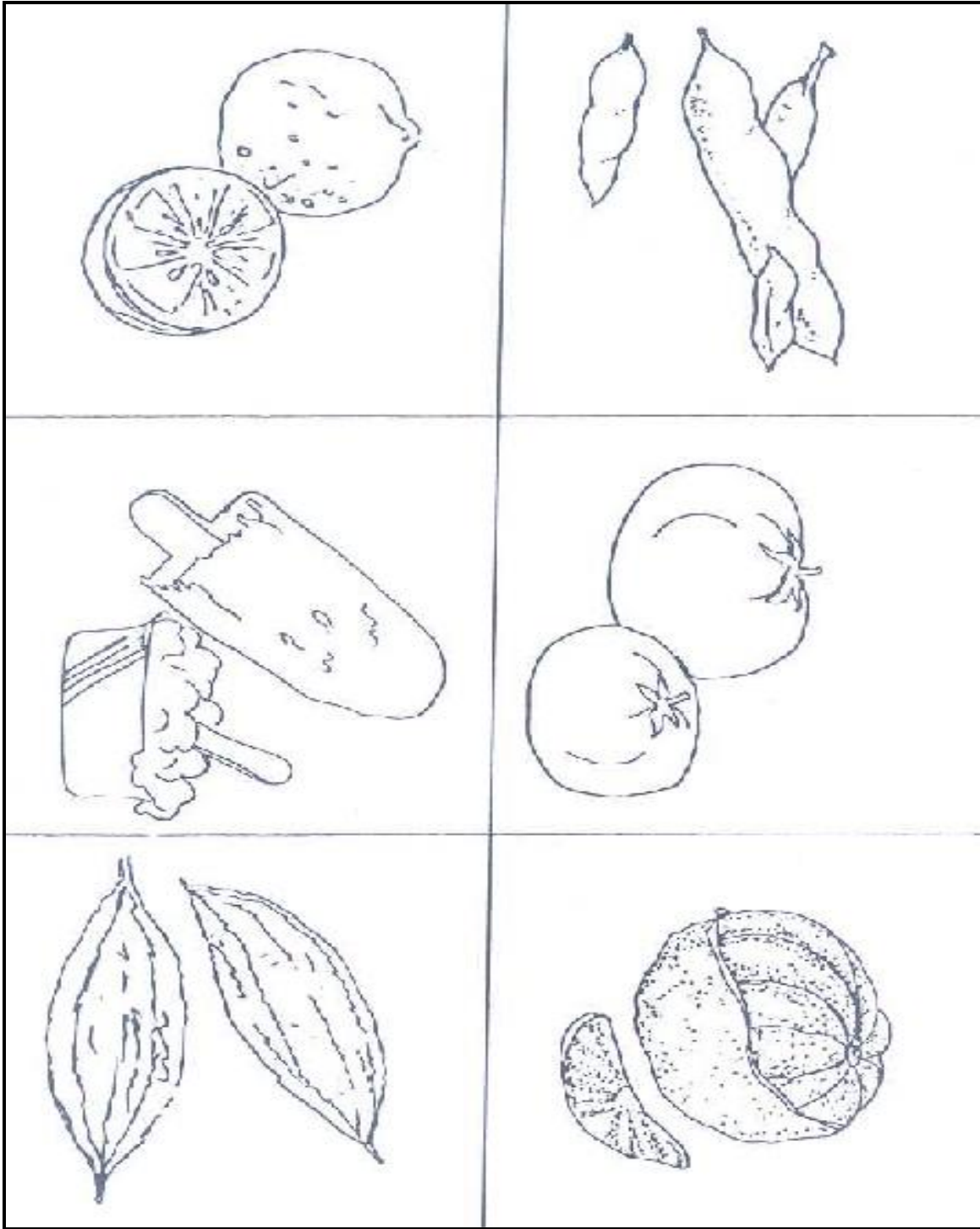

NAME:

DATE:

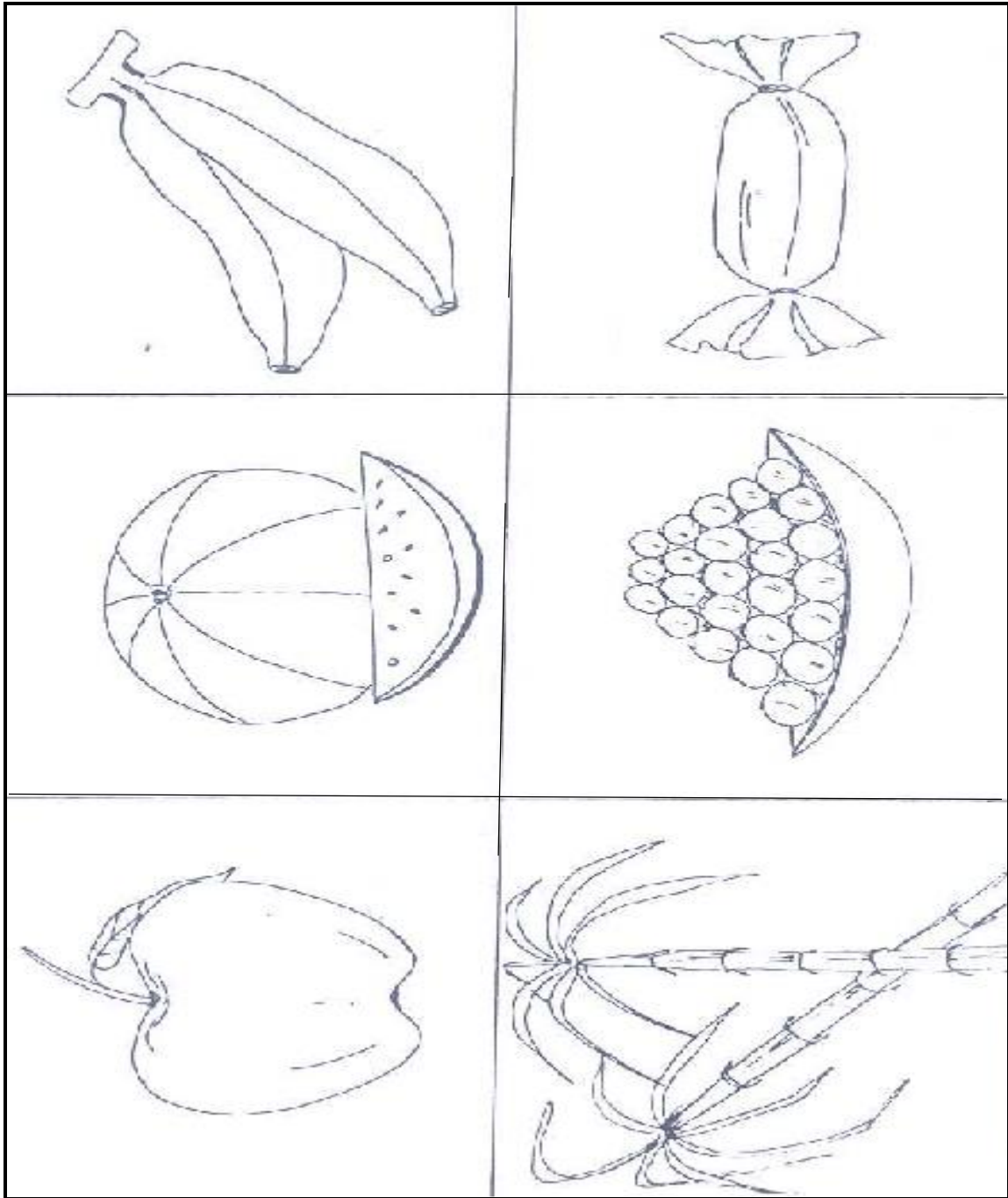

NAME:

DATE:

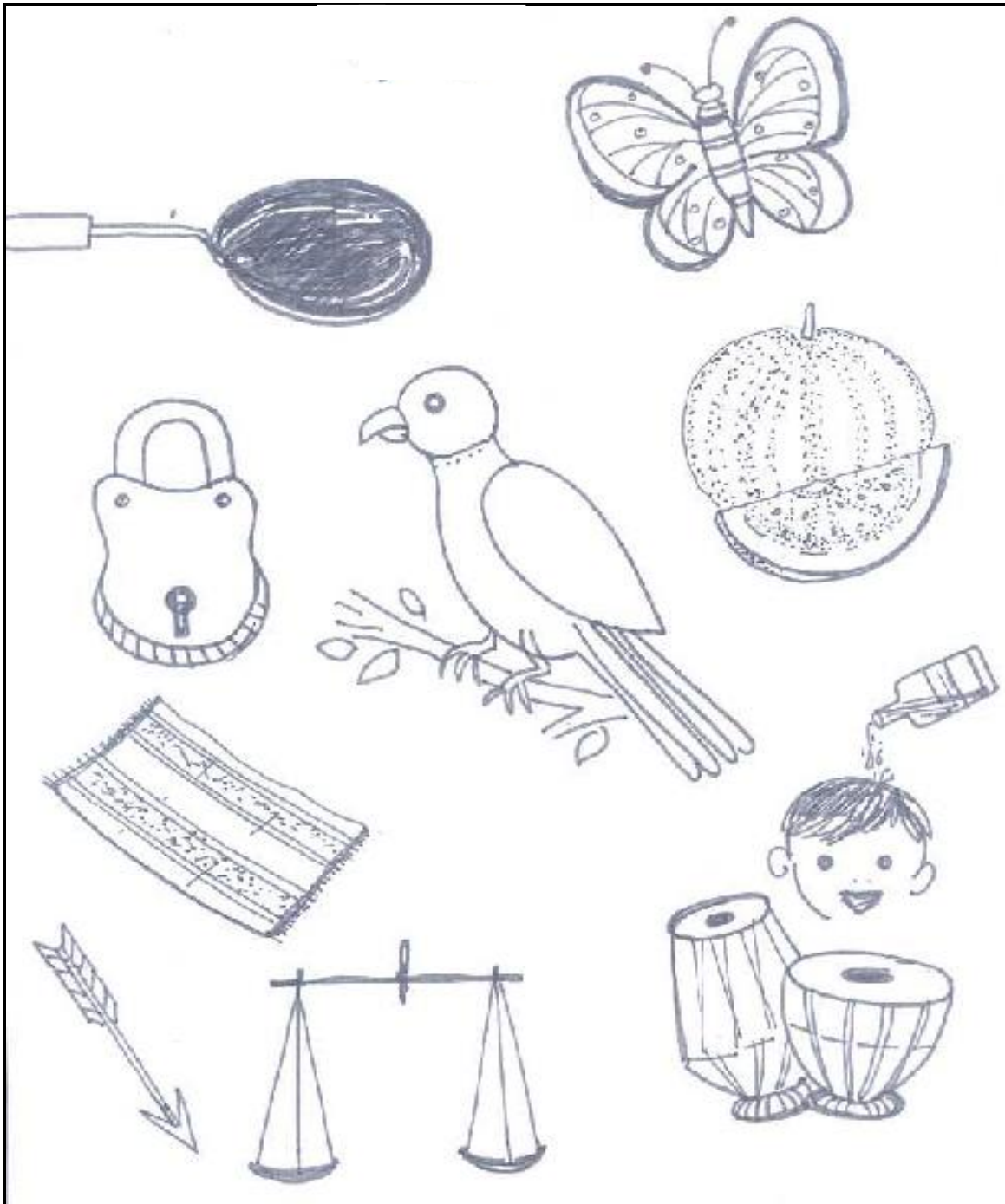

NAME:

DATE:

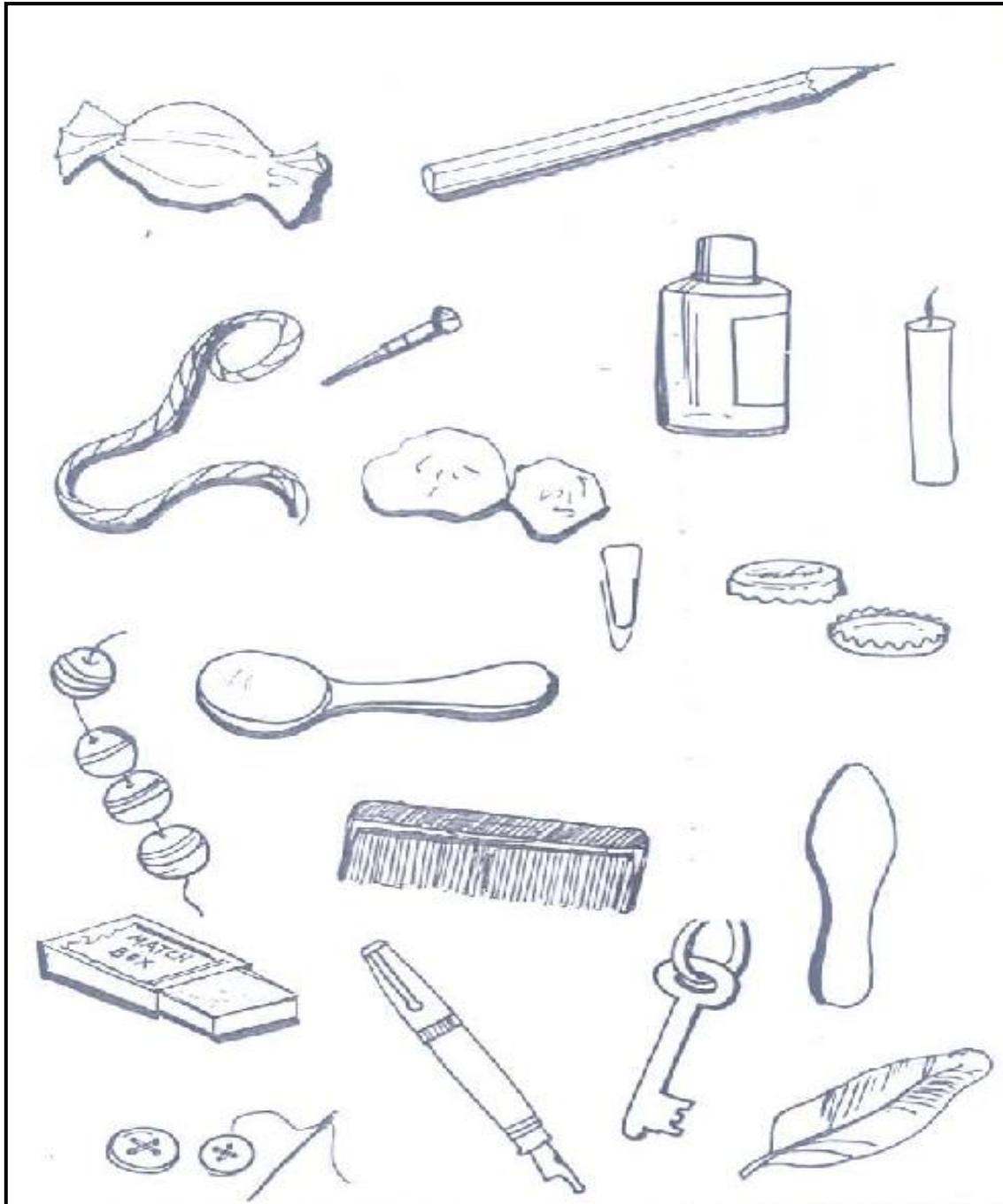

NAME:

DATE:

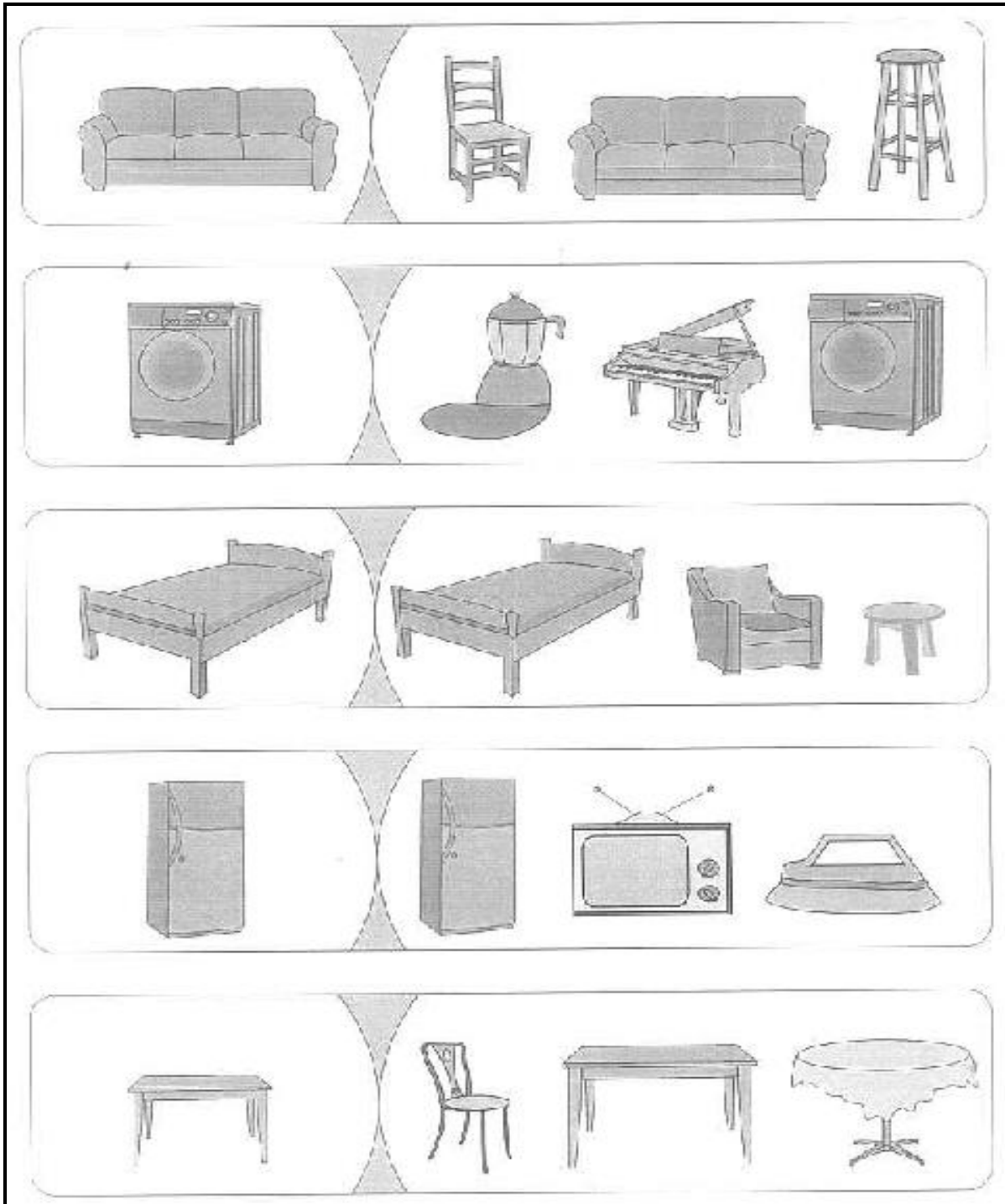

NAME:

DATE:

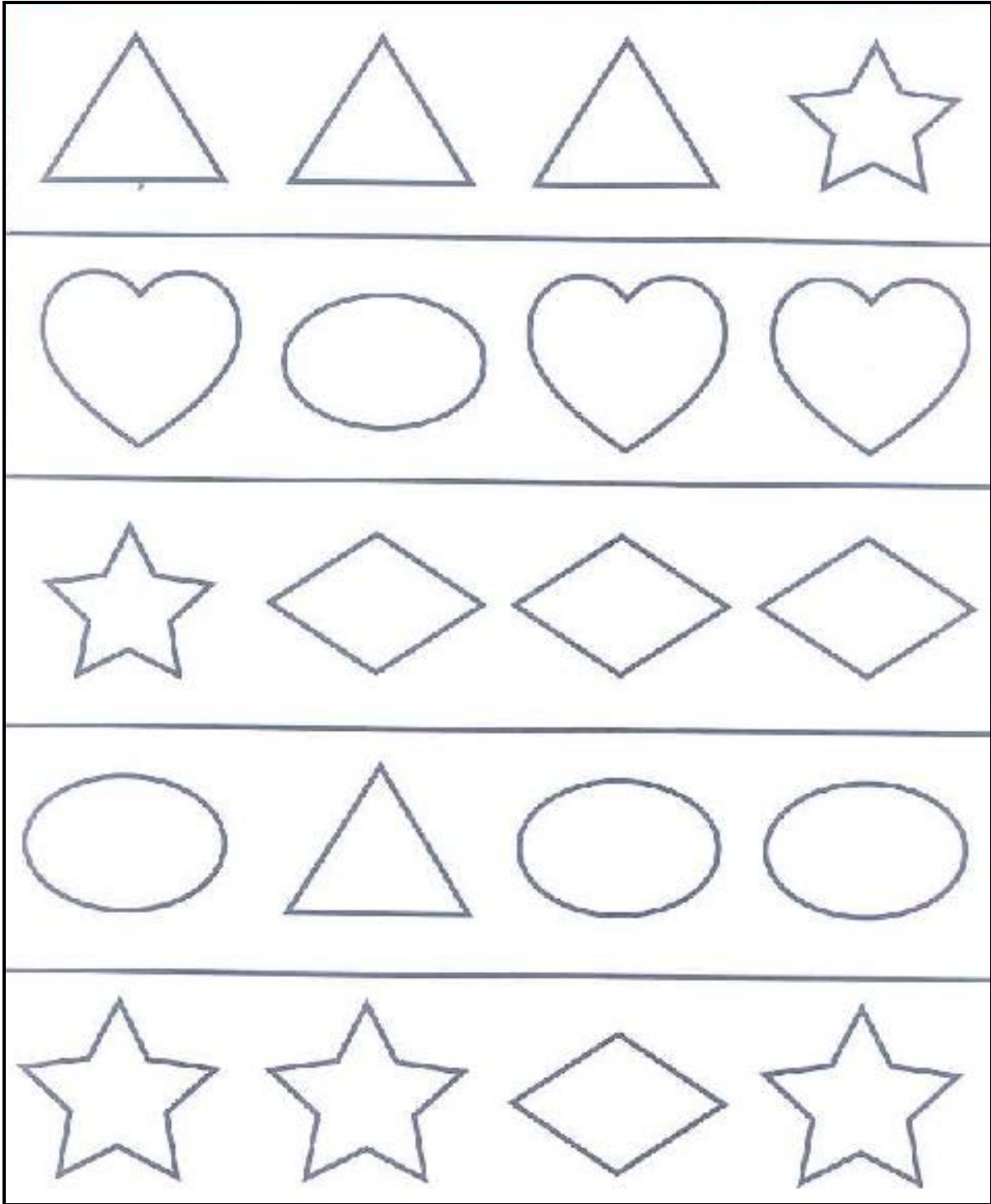

NAME:

DATE:

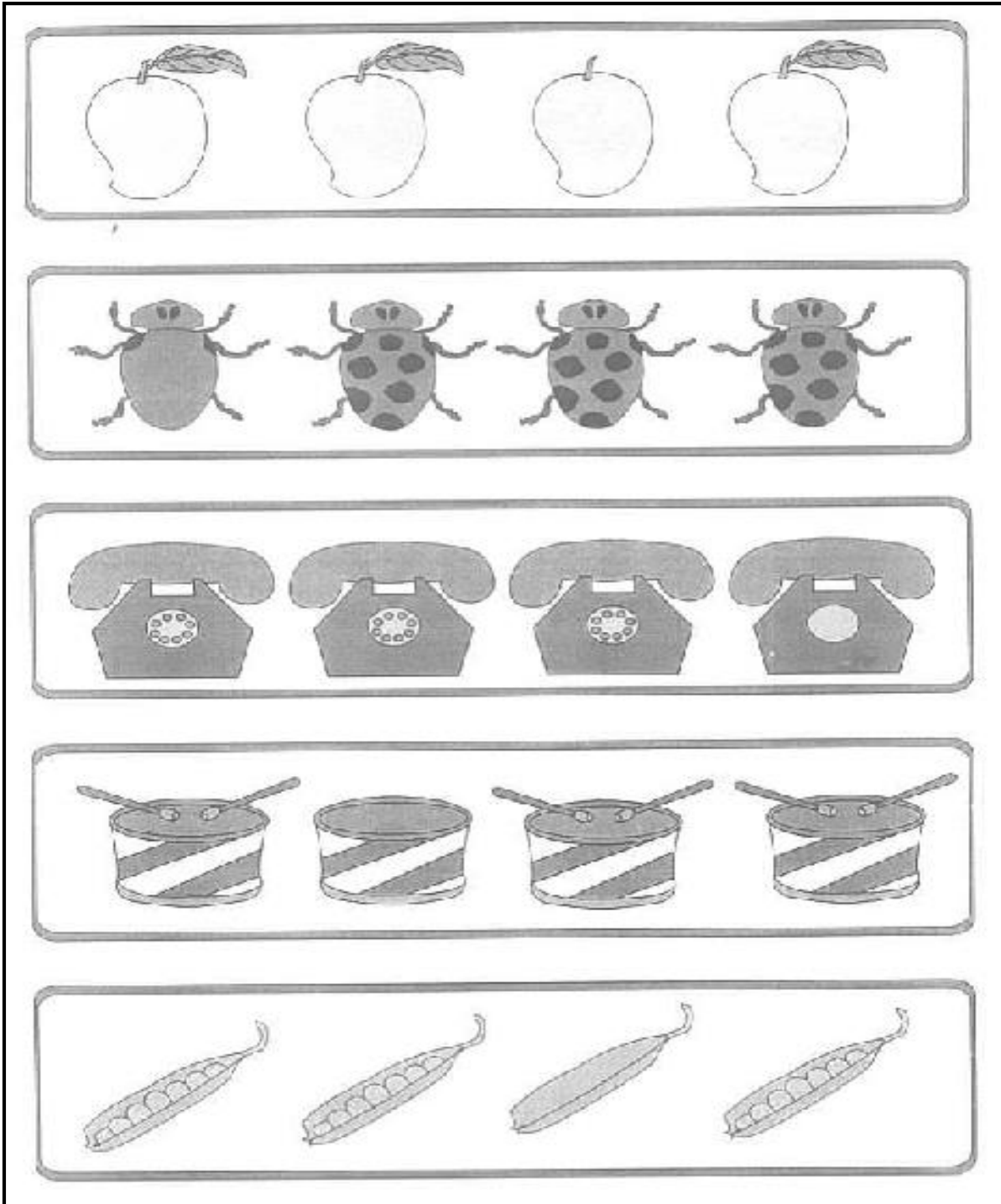

NAME:

DATE:

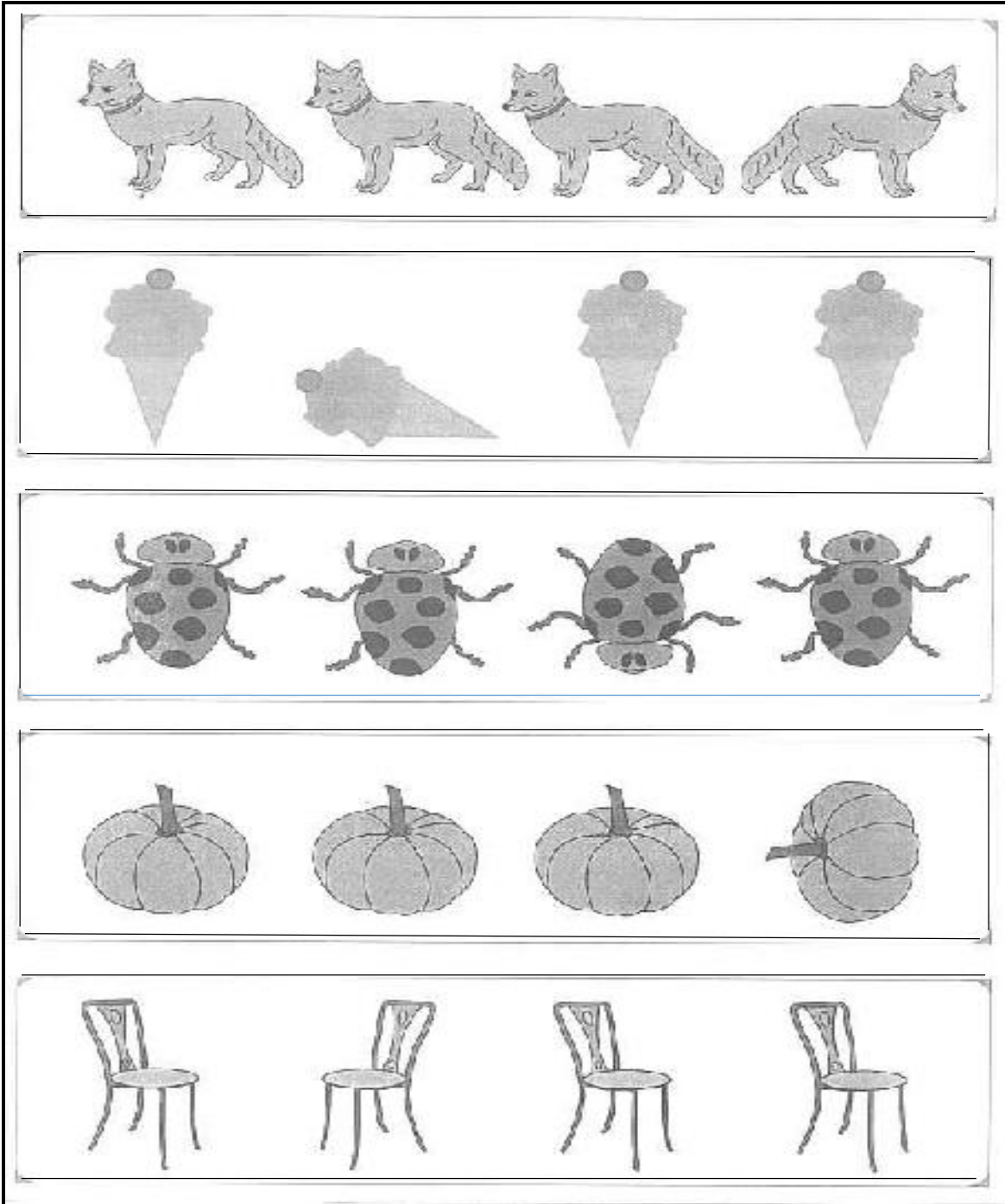

NAME:

DATE:

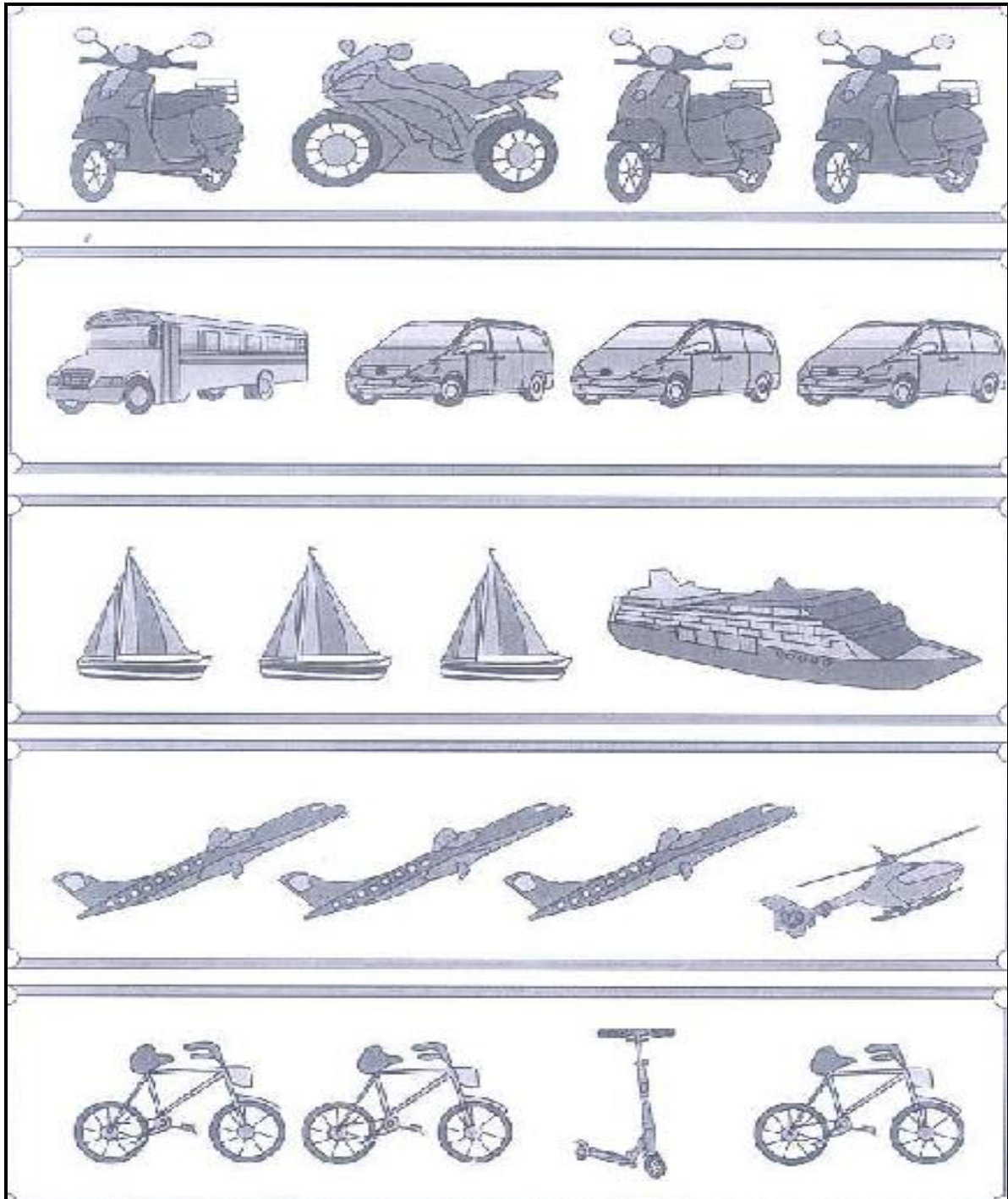

NAME:

DATE:

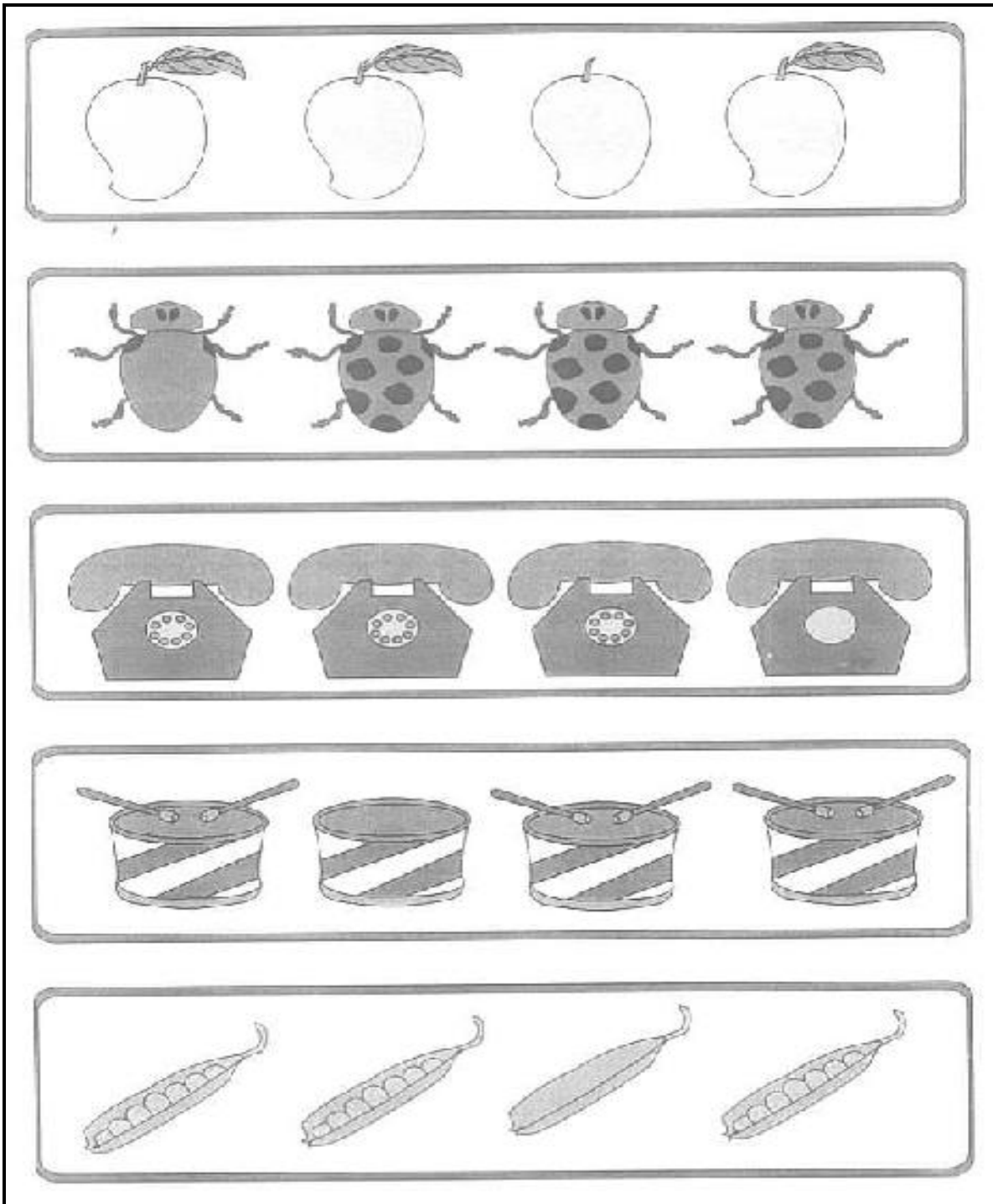

NAME:

DATE:

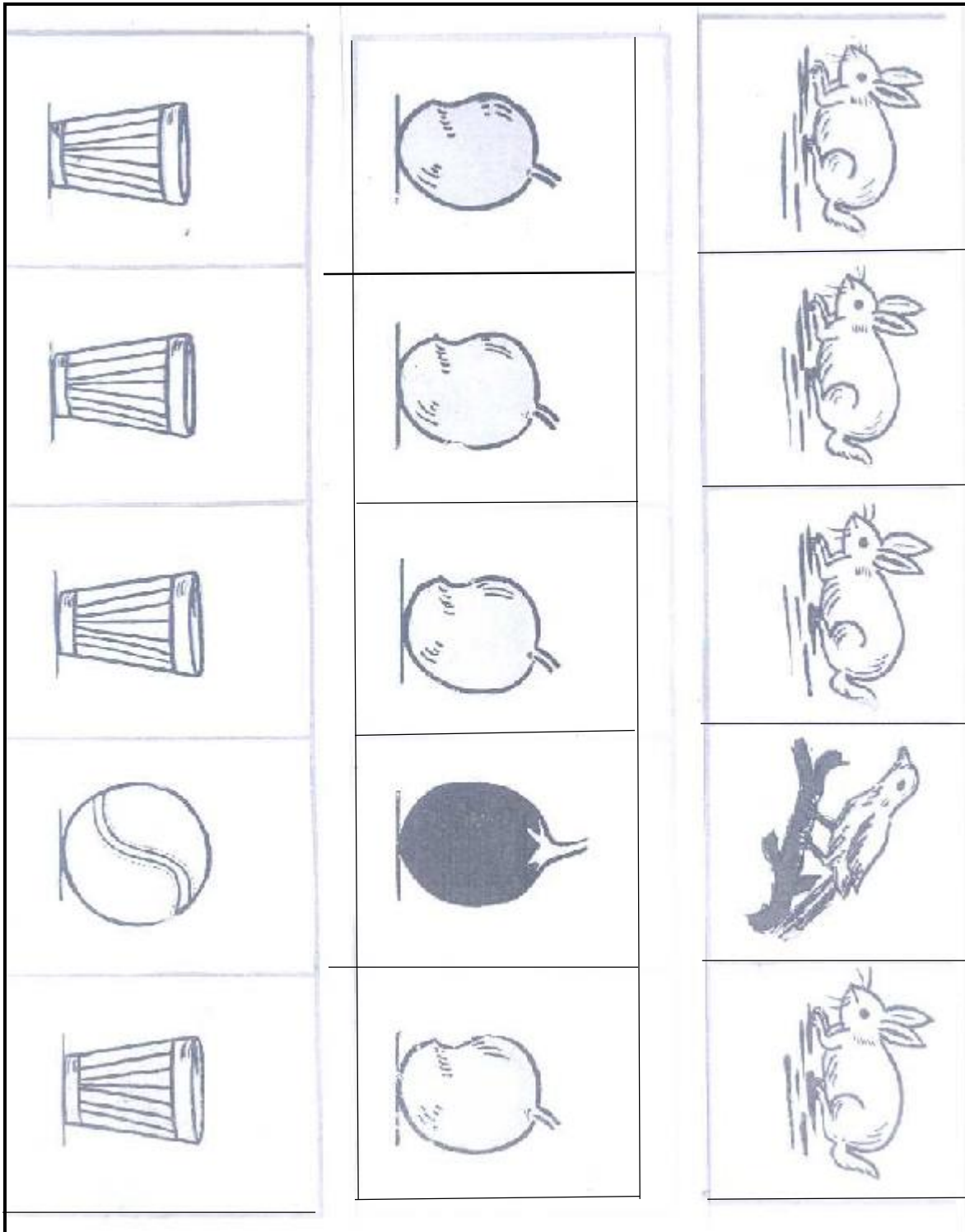

NAME:

DATE:

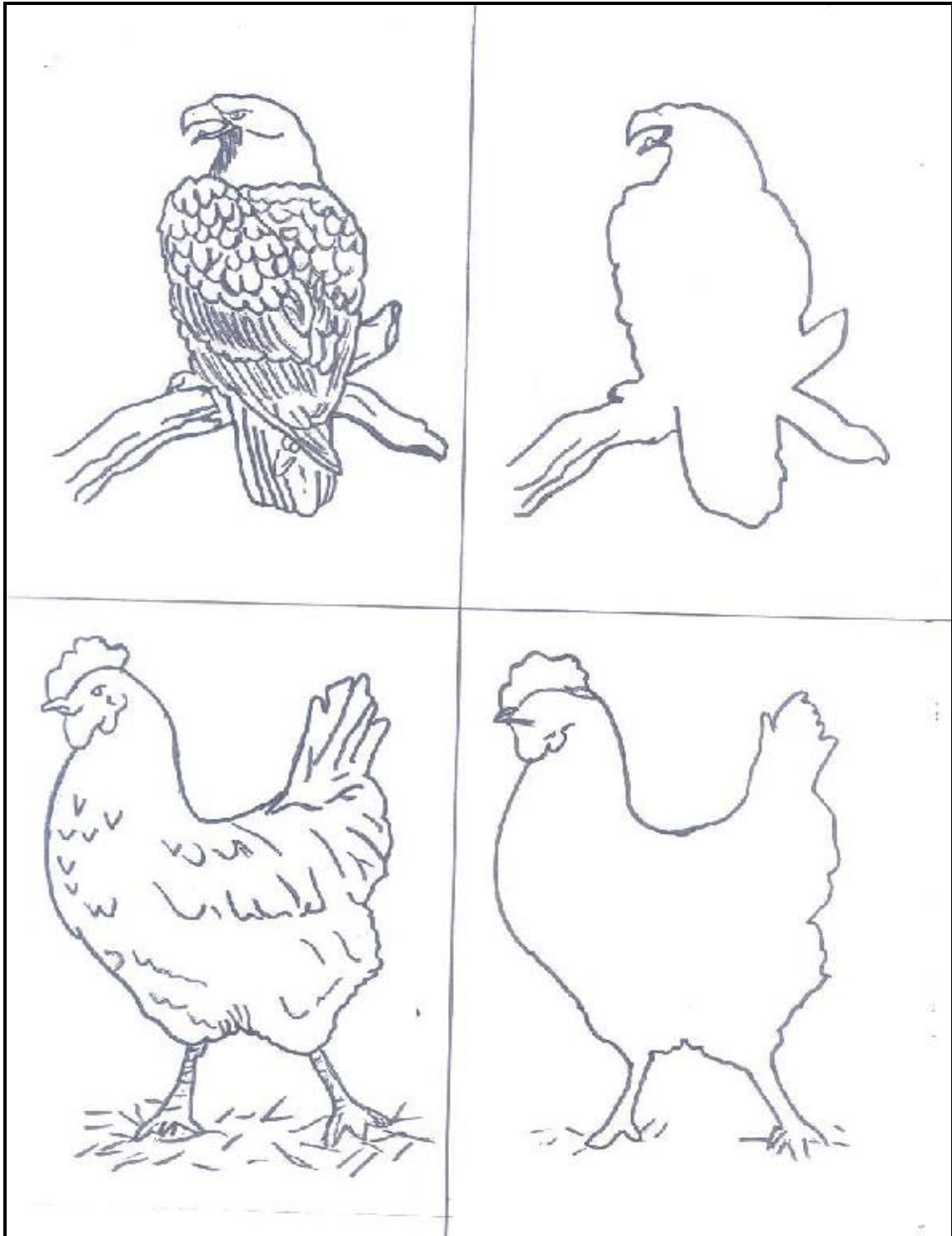





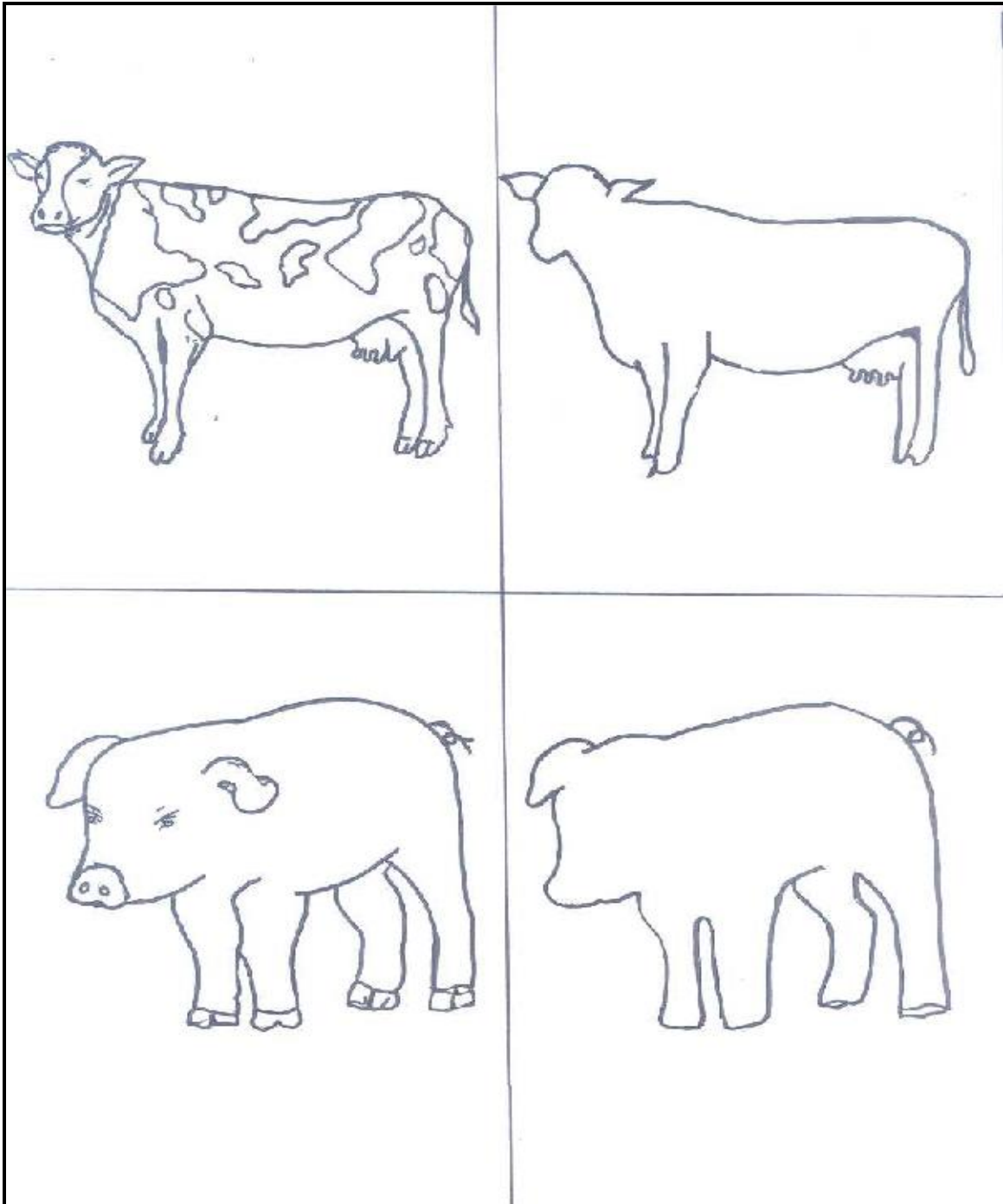







NAME:

DATE:



NAME:

DATE:

| | | |
|---|---|---|
|  <input type="text"/> |  <input type="text"/> |  <input type="text"/> |
|  <input type="text"/> |  <input type="text"/> |  <input type="text"/> |
|  <input type="text"/> |  <input type="text"/> |  <input type="text"/> |
|  <input type="text"/> |  <input type="text"/> |  <input type="text"/> |

NAME:

DATE:

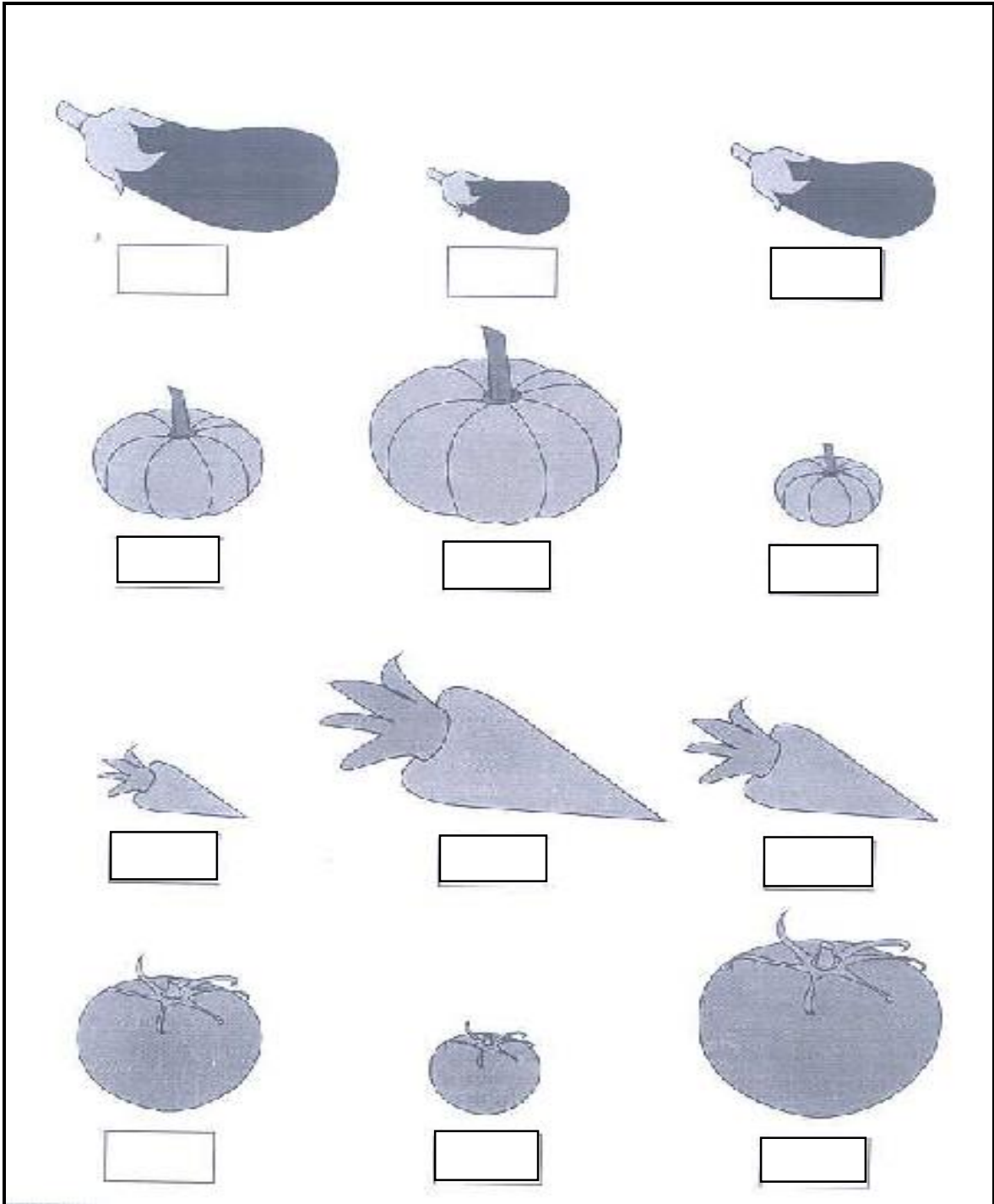

NAME:

DATE:

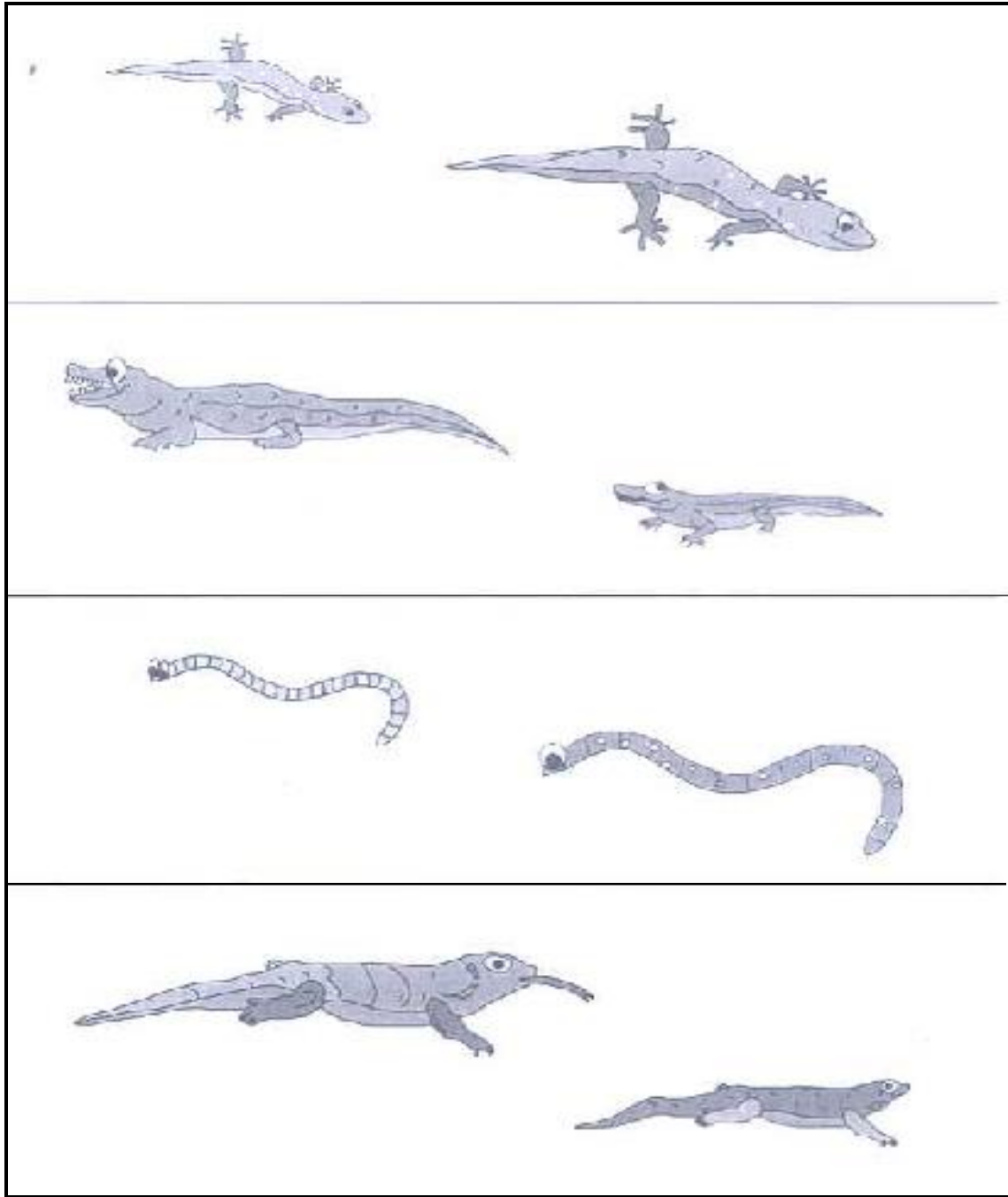

NAME:

DATE:

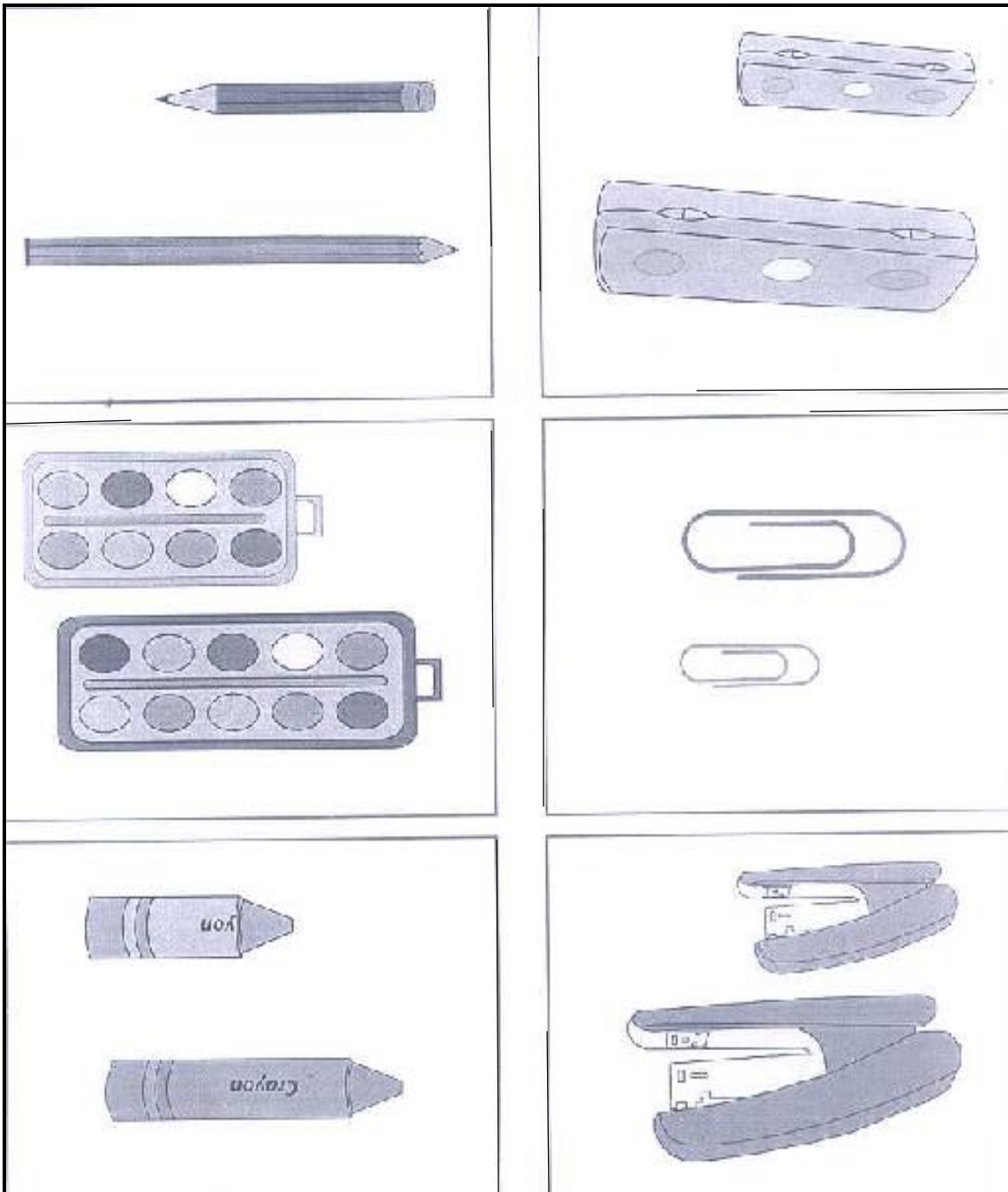





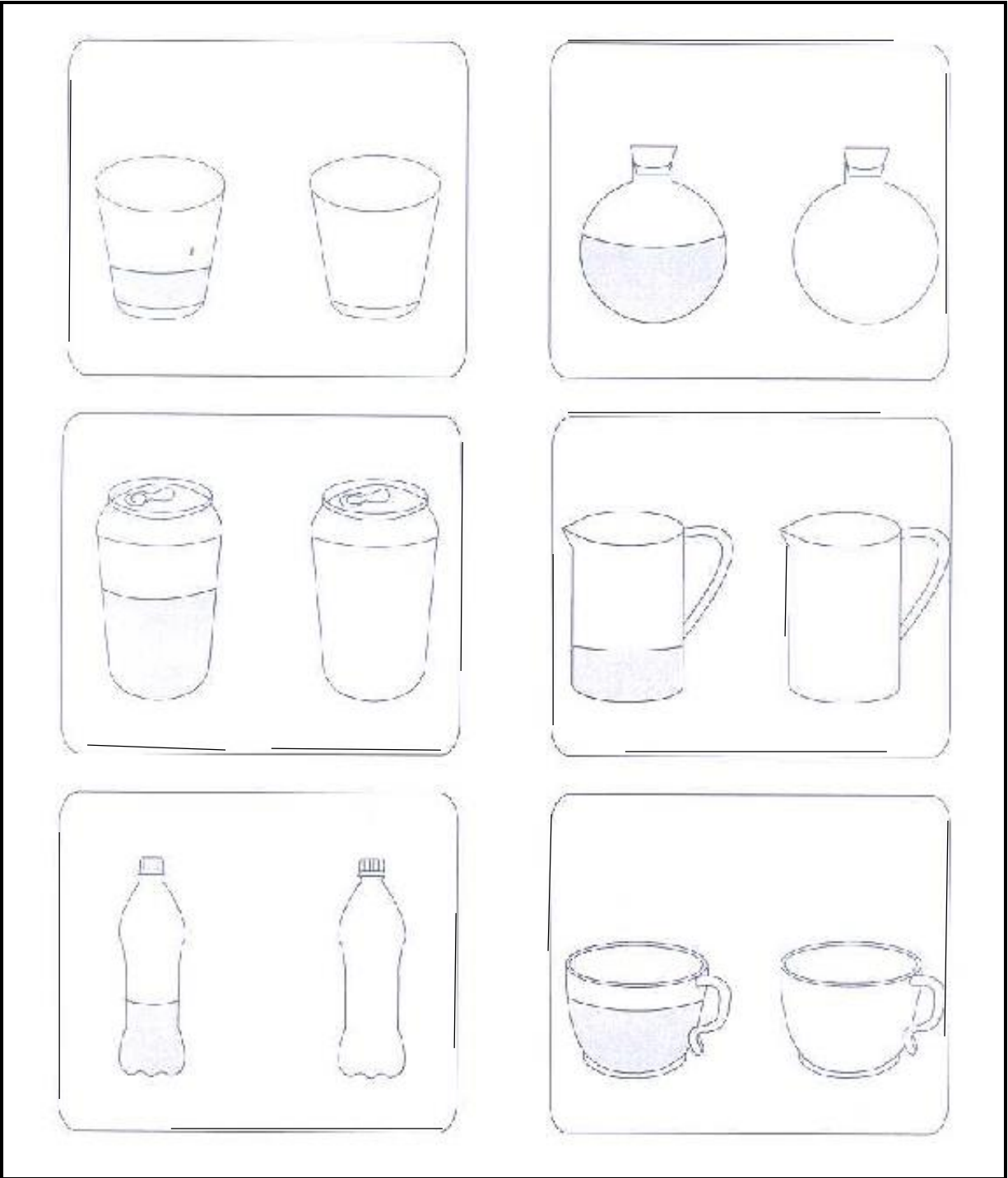

NAME:

DATE:

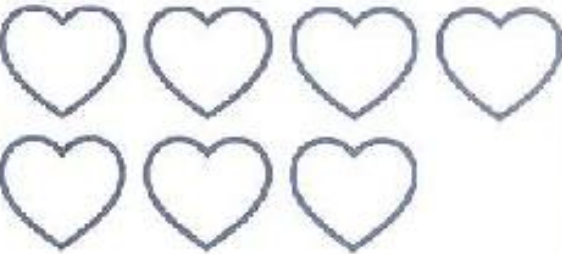

NAME:

DATE:

| | |
|---|--|
|  |  |
|  |  |
|  |  |
|  |  |

NAME:

DATE:

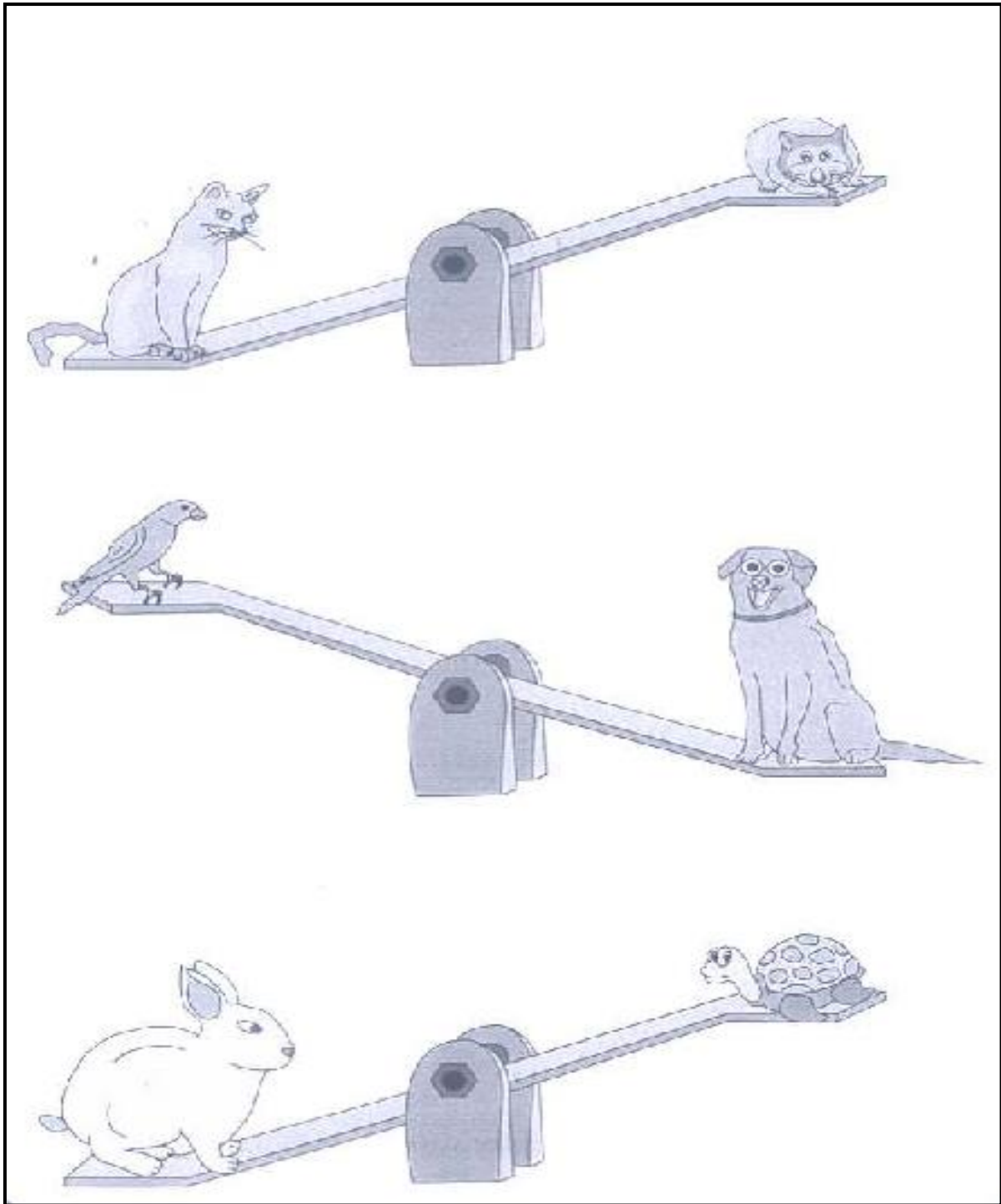

NAME:

DATE:

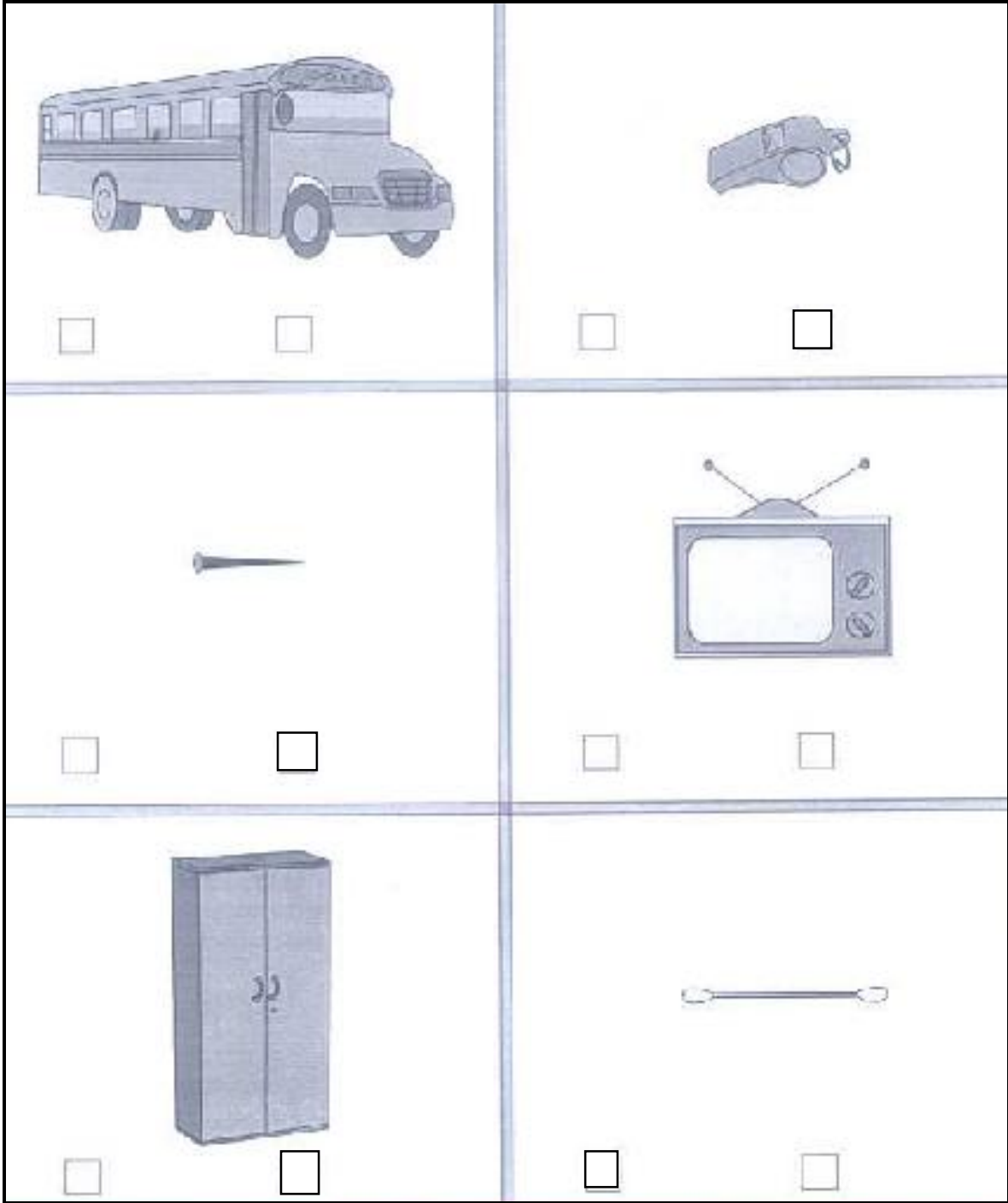

NAME:

DATE:

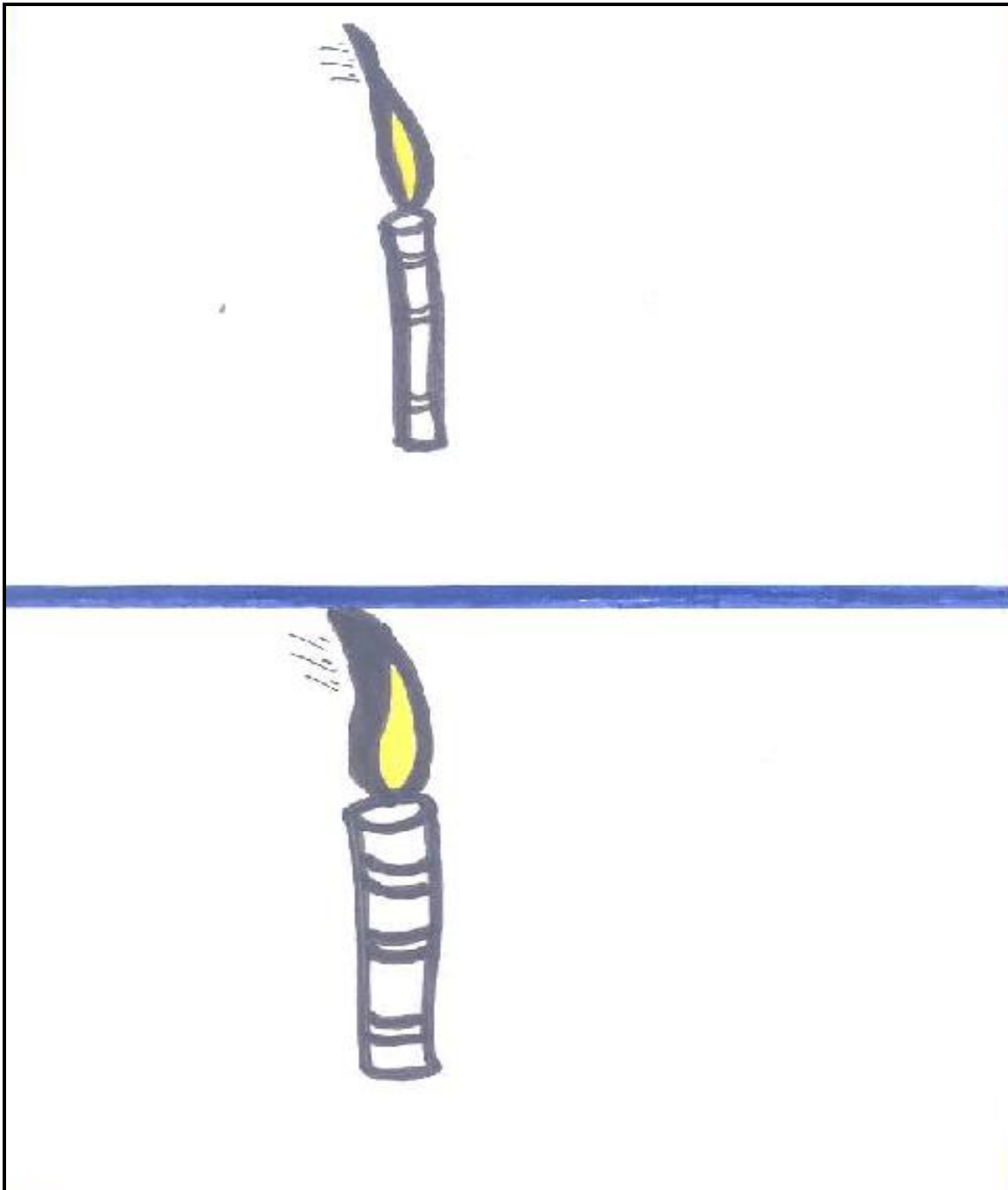

NAME:

DATE:

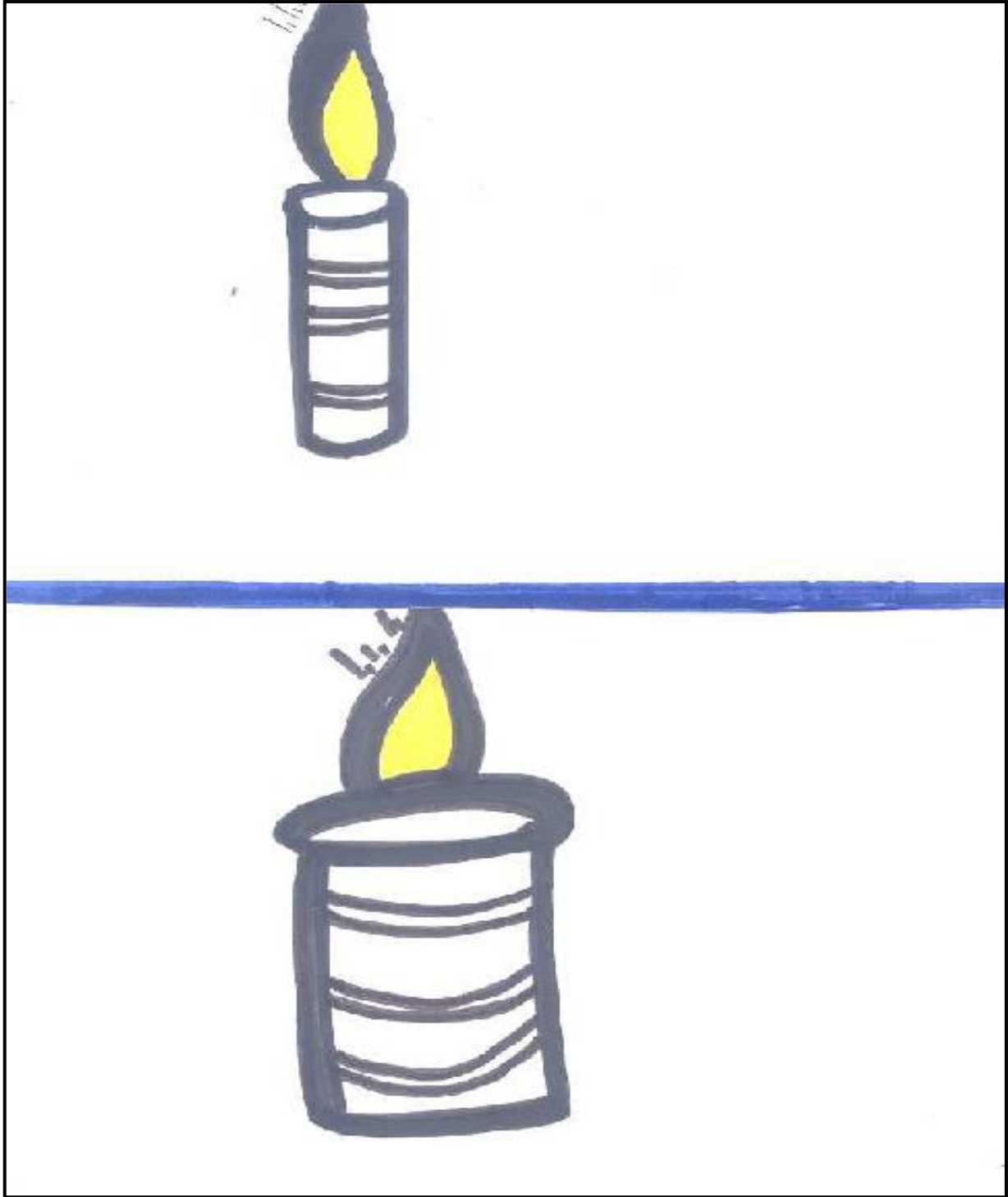

NAME:

DATE:

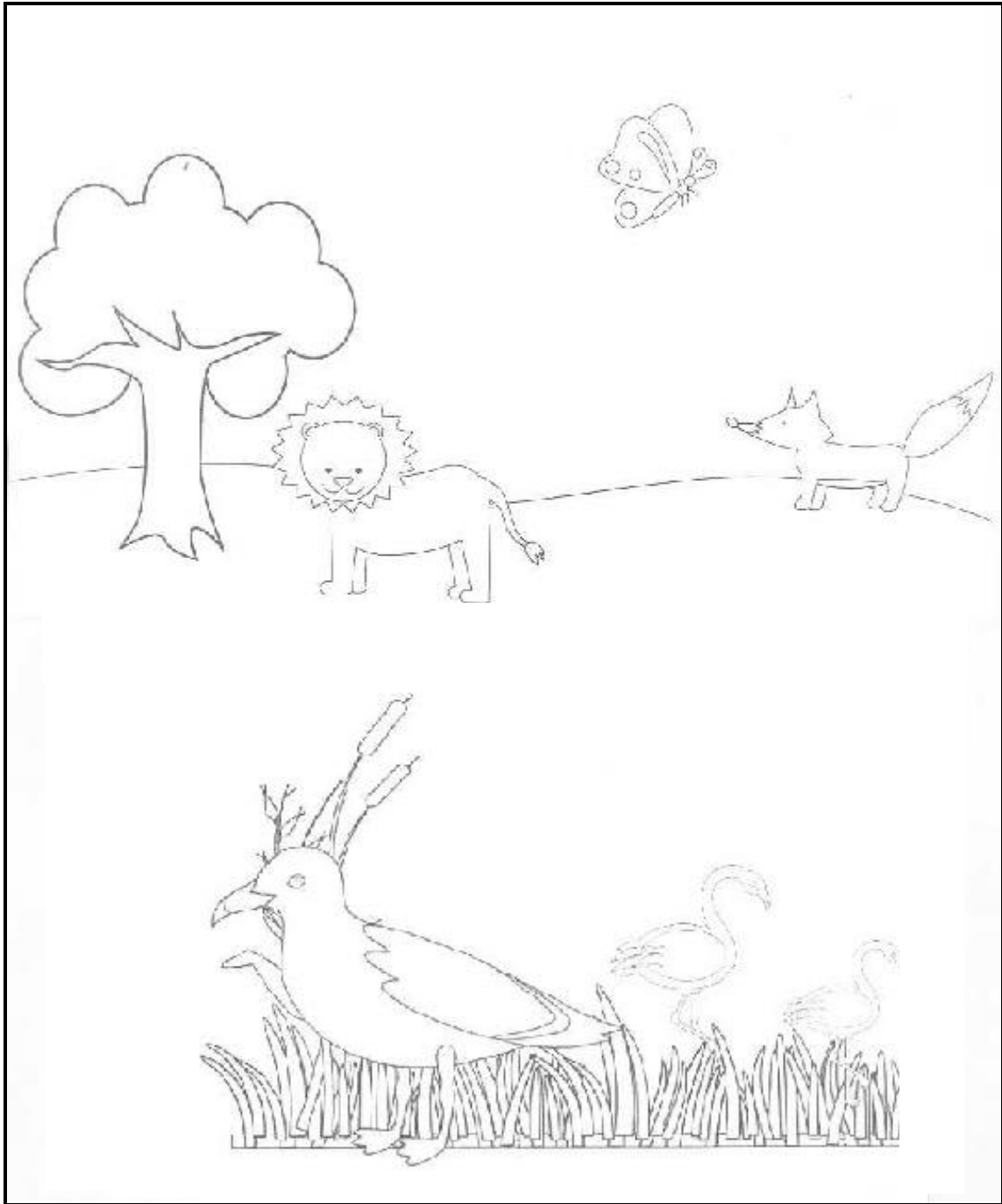

NAME:

DATE:

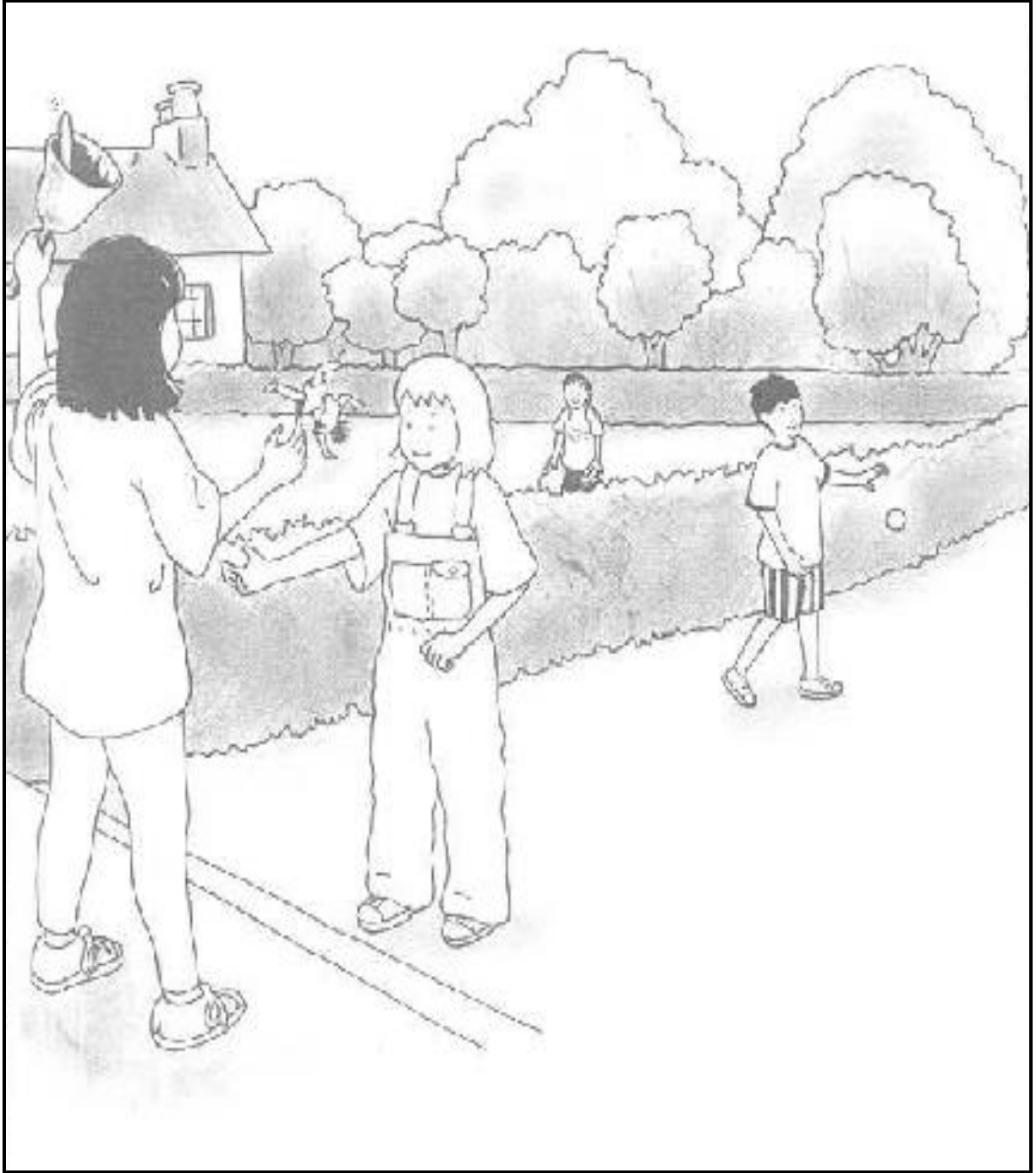

NAME:

DATE:

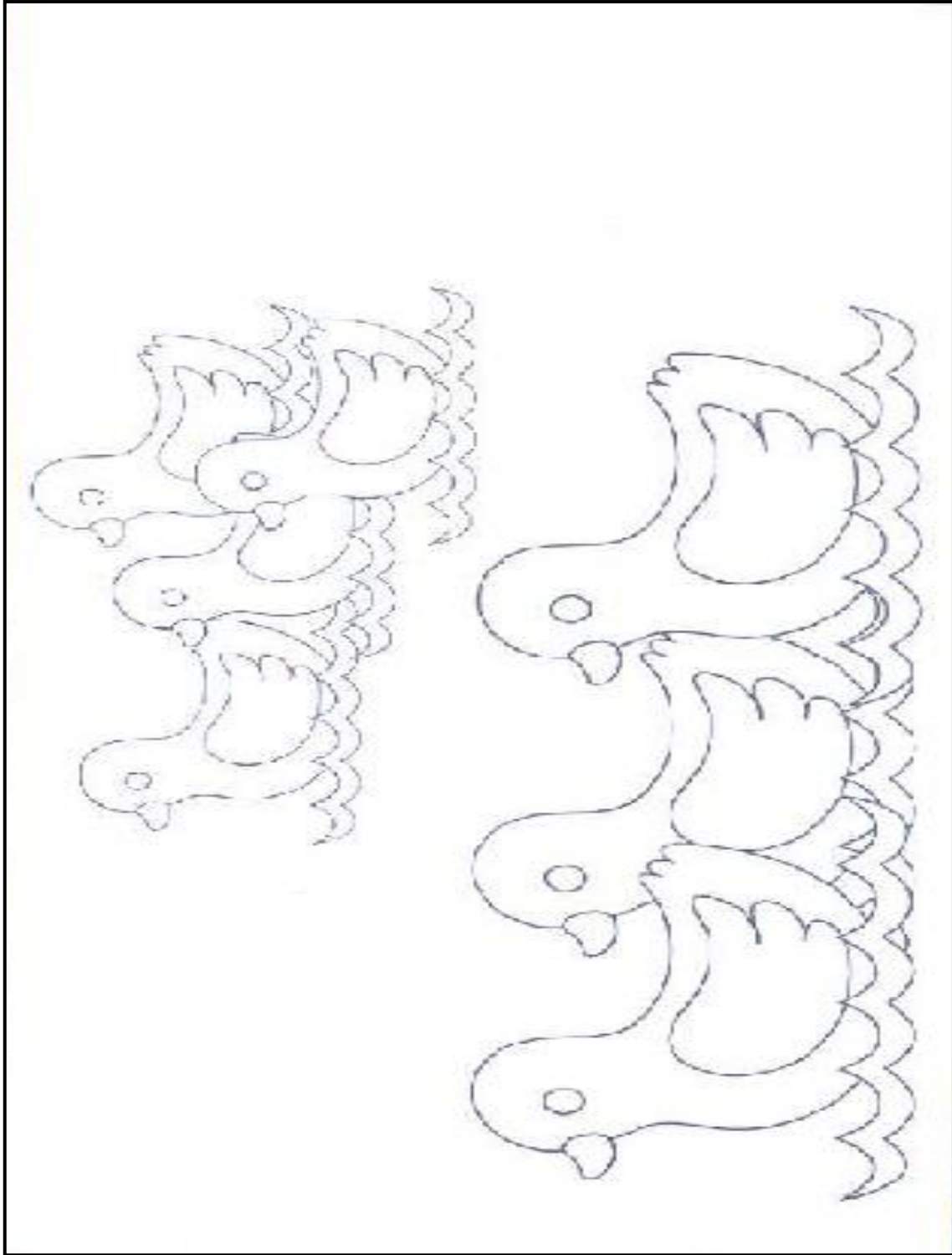

NAME:

DATE:

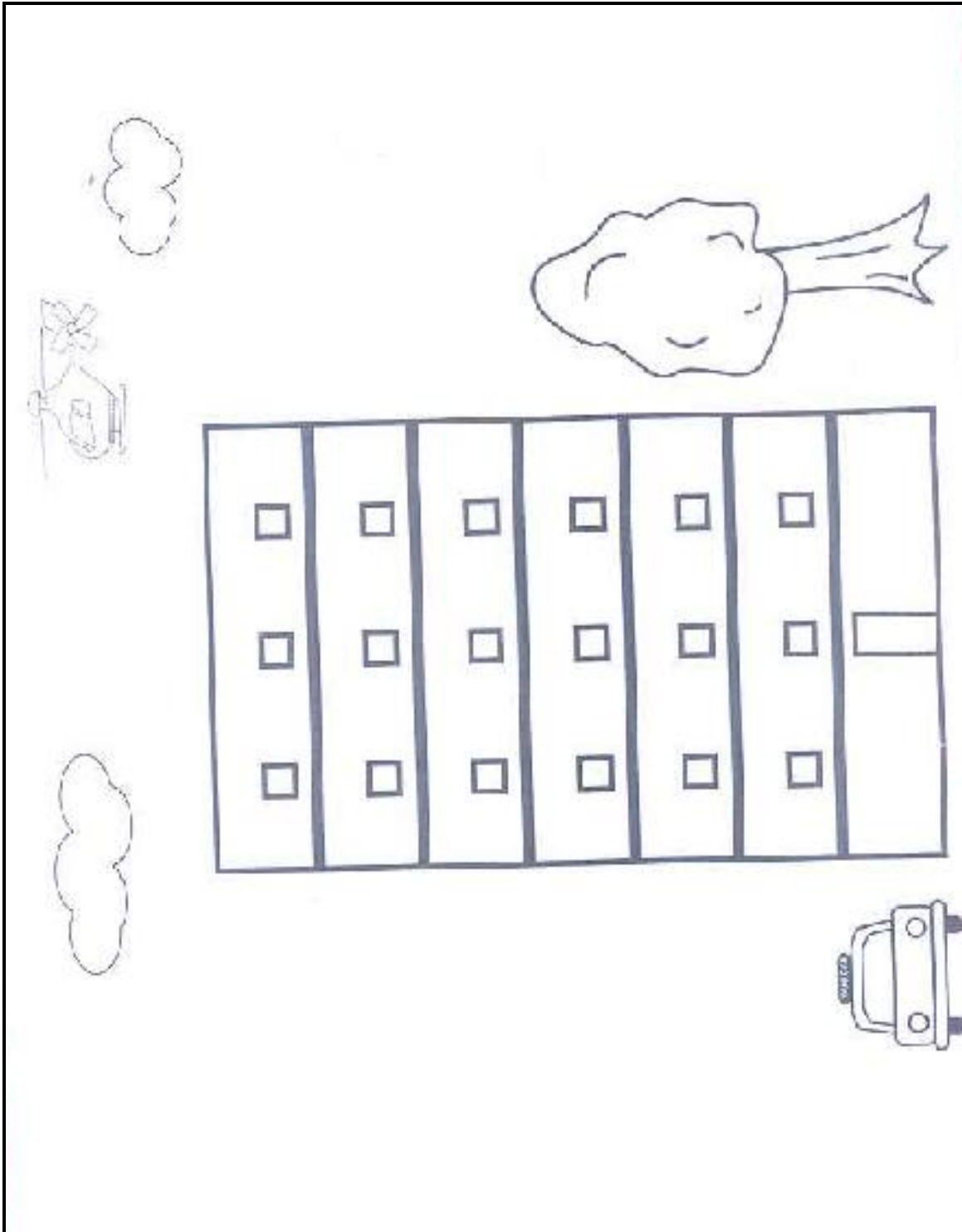

NAME:

DATE:

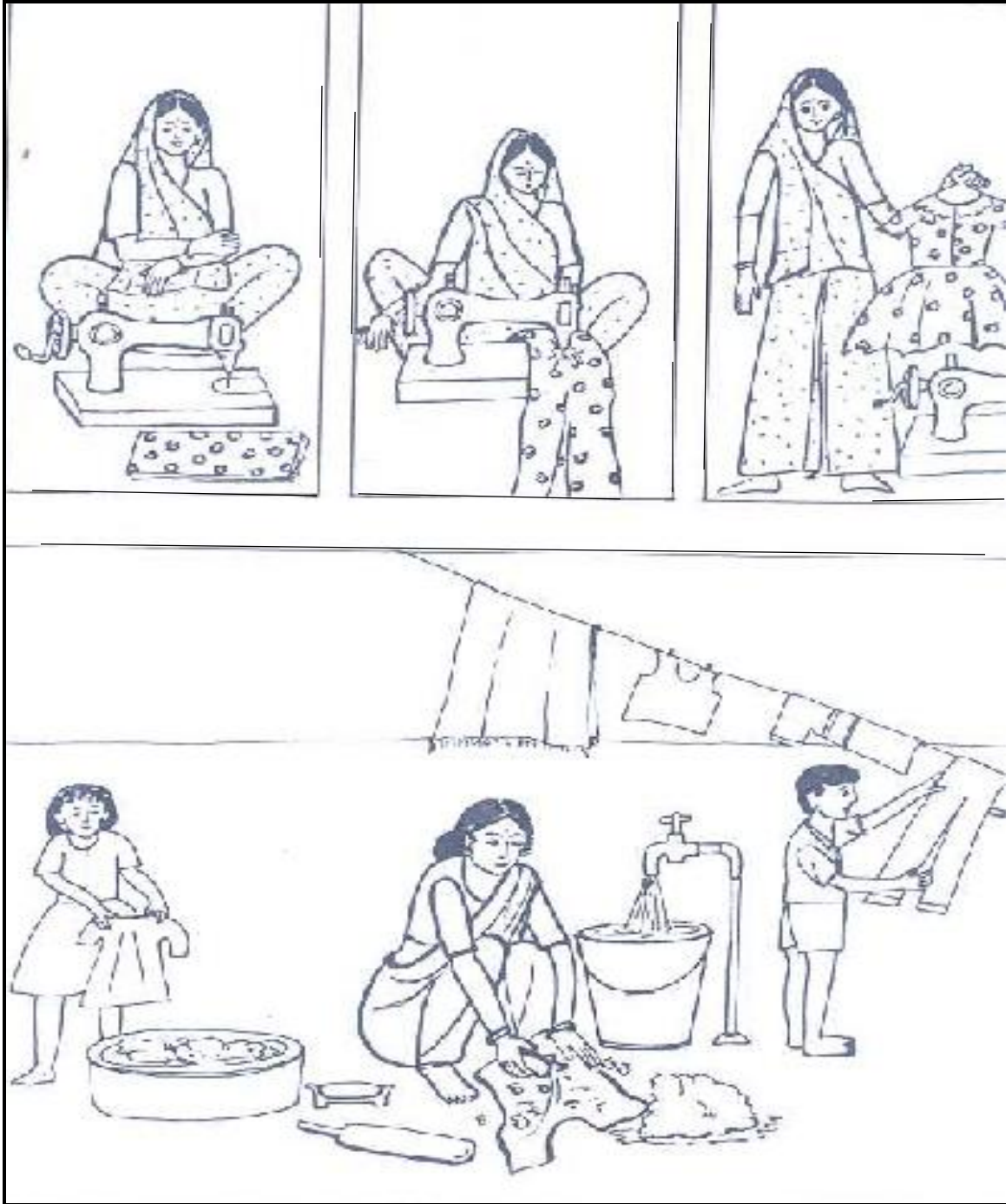

NAME:

DATE:



NAME:

DATE:

